

## NPC SEATING



2,000,000 SEATS  
50 YEARS

# INDEX

**W**e do not sell products, we sell trust. Our corporate vision states:

*Be one of the world's leading manufacturers and providers of public seating solution by Committing to providing the highest level of quality in service and products; Cultivating lasting relationship with customers and employees; and Focusing on driving sustainable, long-term growth.*

Since the foundation in 1987, NPC SEATING has provided high quality spectator seats and retractable seating platforms that enhance the experience of millions of spectators who come to watch sports games, movies and various performances. Based on the customer satisfaction and trust we have built over many years, NPC SEATING strives to continually enhance our services to exceed customers' expectations.

SPECTATOR SEATS	06
Tip up	08
Non tip up	24
Featured projects	34
RETRACTABLE SEATING PLATFORM	44
Platform	46
Seats	52
Featured projects	60
GRANDSTAND / BLEACHER	70
MULTI PURPOSE HALL	74
BENCH	82
CERTIFICATES	84

# SPECTATOR SEATS

Spectator seats at public venues, particularly at sports facilities, experience complicated and high level of stress: they must endure not only direct impact and repeated loading/unloading but also exposure to years of ultraviolet light, precipitation, humidity and change of temperature. Due to this challenge, many seating companies fail to maintain their product qualities only few years after the installation. NPC SEATING's partnership with global top tier raw material providers as well as 50 years of manufacturing experience ensure our customers enjoy the most durable yet comfortable spectator seats in the industry.



Project : Hwaseong Sports Complex  
Model : NSC-2030  
Number of seats : 40,985

# Options for tip up seats

## Floor mount



## Wall mount



## Armrest



## Seat number

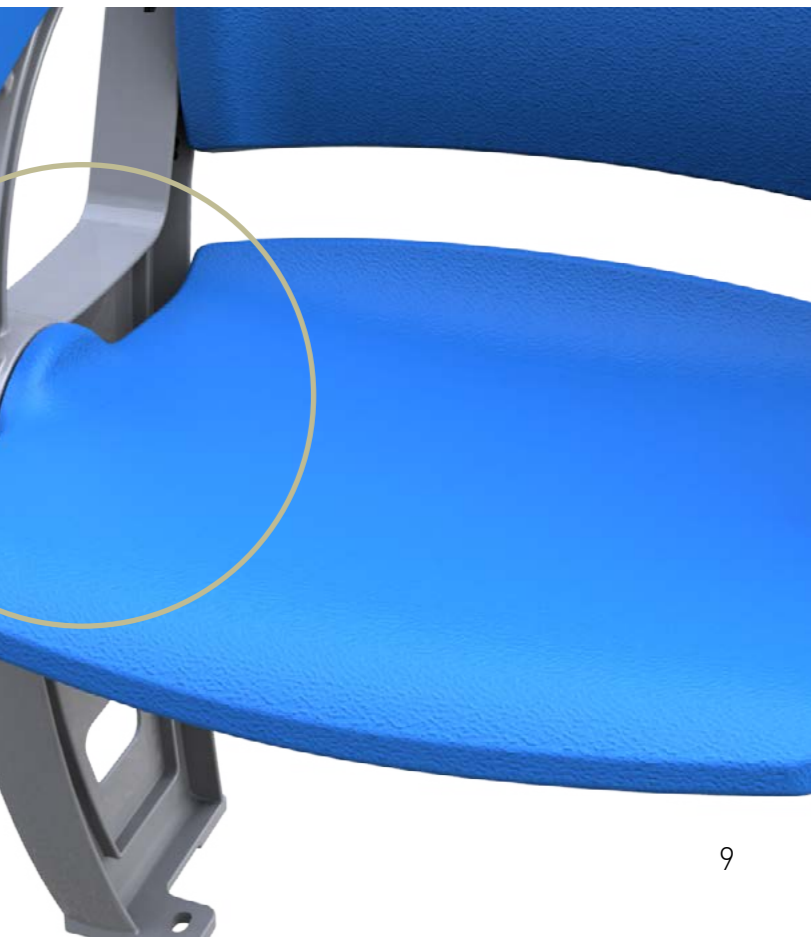
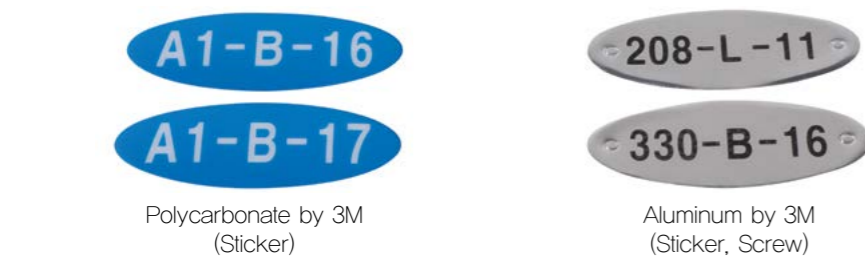

\*All our spectator seats have anti-finger jam mechanism for the safety of the users.

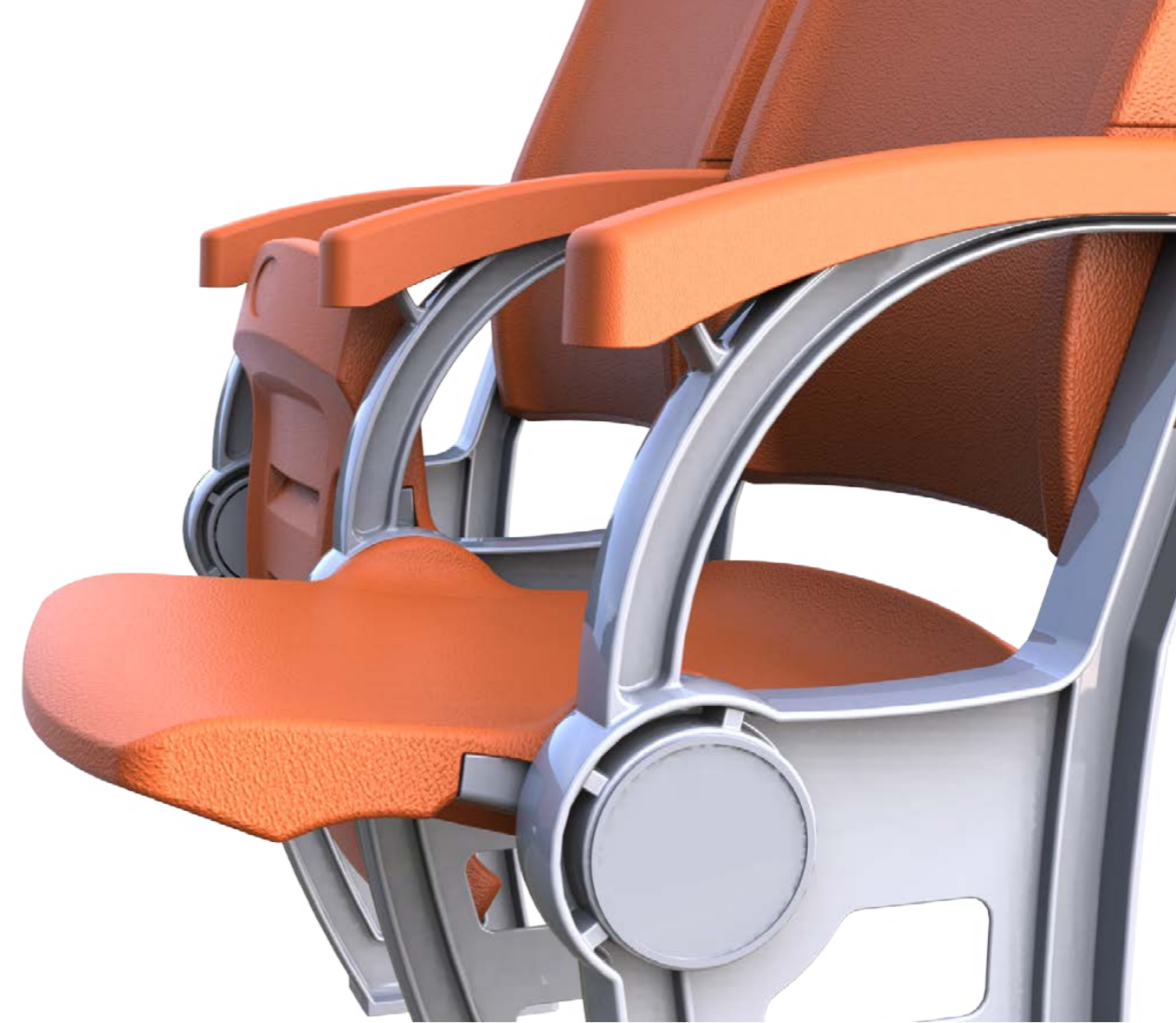

# NSC 2011

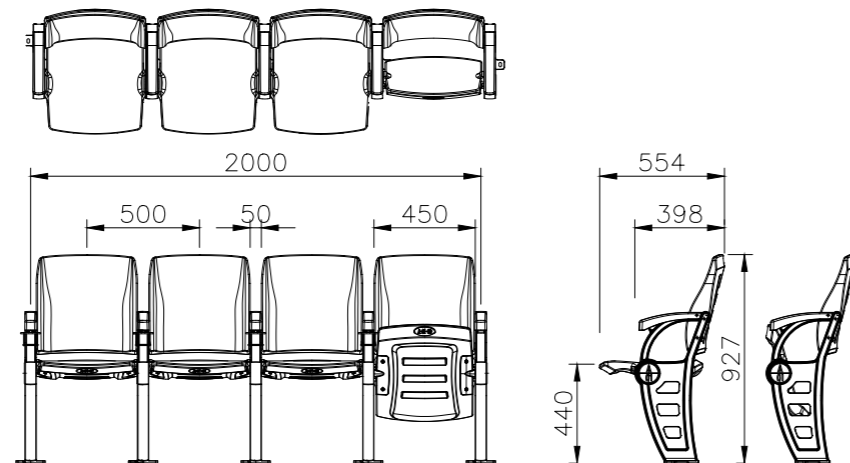

### Color option



<b>Material</b>	Seat, back, armrest: High Density Polyethylene (HDPE) Frame: Aluminum die casting
<b>Size (mm)</b>	W450 x D554 x H927
<b>Finish</b>	Powder coating
<b>Molding type</b>	Blow molding
<b>Application</b>	Stadium, Arena

NSC 2011 is a blow molded, gravity fold spectator seat with its frame made of aluminum to enhance strength and durability.

Its ergonomic design as well as hollow space that acts as an air cushion provide maximum comfort to the user.

NSC 2011 is a popular choice for both VIPs and general spectators.



# NSC 2020

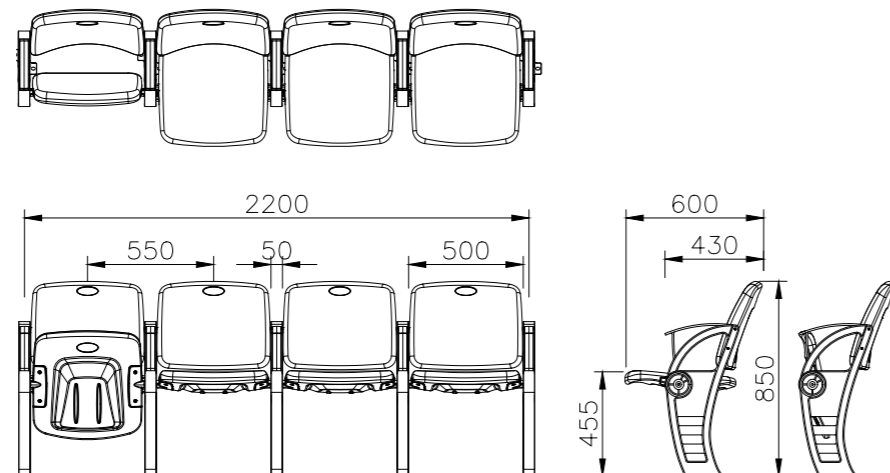

### Color option



<b>Material</b>	Seat, back, armrest: High Density Polyethylene (HDPE)
	Frame: Aluminum die casting
<b>Size</b>	W500 x D600 x H850
<b>Finish</b>	Powder coating
<b>Molding type</b>	Blow molding
<b>Application</b>	Stadium, Arena

NSC 2020 is a blow molded, gravity fold spectator seat with its frame made of aluminum to enhance strength and durability.

Its ergonomic design as well as hollow space that acts as an air cushion provide maximum comfort to the user.

NSC 2020 is a popular choice for both VIPs and general spectators.



# NSC 2030

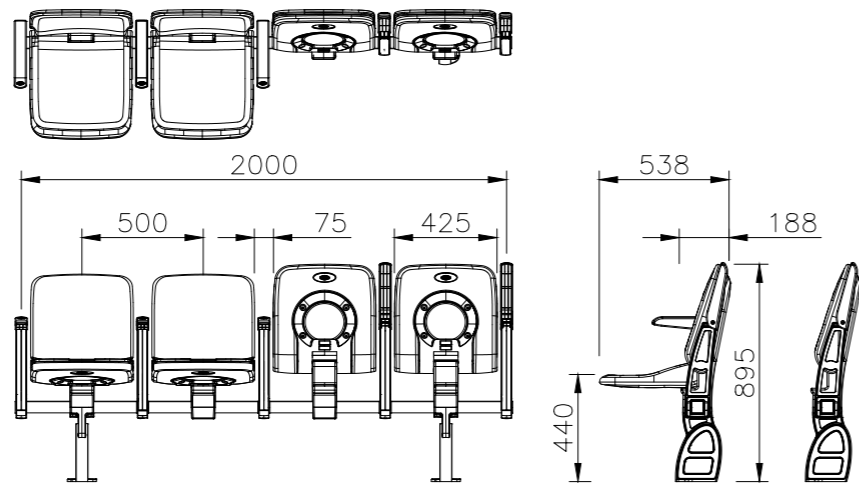

### Color option



<b>Material</b>	Seat, back: High Density Polyethylene (HDPE)
	Armrest: Nylon
	Frame: Aluminum die casting
<b>Size (mm)</b>	W425 x D538 x H895
<b>Finish</b>	Powder coating
<b>Molding type</b>	Blow molding
<b>Application</b>	Stadium, Arena

NSC 2030 is a blow molded, spring fold spectator seat with its frame made of aluminum to enhance strength and durability. Its ergonomic design as well as hollow space that acts as an air cushion provide maximum comfort to the user.

NSC 2030 is mounted on beam so that its seat center can be adjusted between 450–550mm, providing flexible arrangement options. When the seat is in the tip up position, it fully covers the backrest, protecting the surface where the spectators make direct contact and allowing added leg room as well as wide walkway access.

NSC 2030 is a popular choice for both VIPs and general spectators.





# NSC 2040

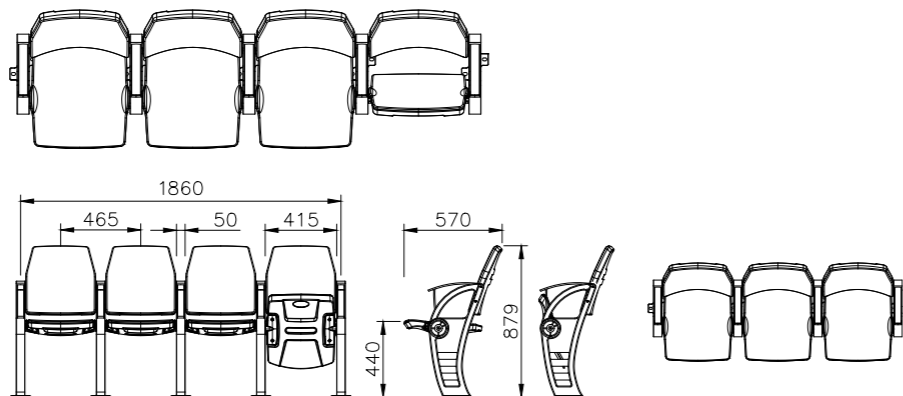

Color option



<b>Material</b>	Seat, back: High Density Polyethylene (HDPE)
	Frame: Aluminum die casting
<b>Size (mm)</b>	W415 x D570 x H879
<b>Finish</b>	Powder coating
<b>Molding type</b>	Blow molding
<b>Application</b>	Stadium, Arena

NSC 2040 is a blow molded, gravity fold spectator seat with its frame made of aluminum to enhance strength and durability.

Its ergonomic design as well as hollow space that acts as an air cushion provide maximum comfort to the user.

NSC 2040 is a popular choice for general spectators.



# NSC 2050

Color option

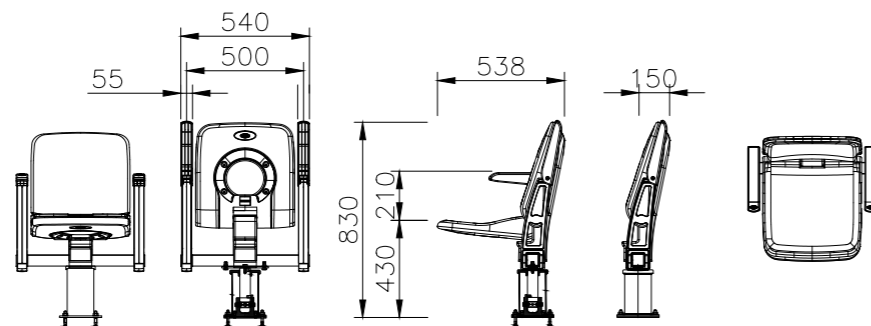

Material	Seat, back: High Density Polyethylene (HDPE)
	Armrest: Nylon
	Frame: Aluminum die casting
Size (mm)	Cylinder: Steel
	W500 x D538 x H830
Finish	Powder coating
Molding type	Blow molding
Application	Stadium, Arena

NSC 2050 is a spring fold spectator seat for the disabled.

It can make 90 degree anticlockwise rotation for easier access (patented).



# NSC 2051

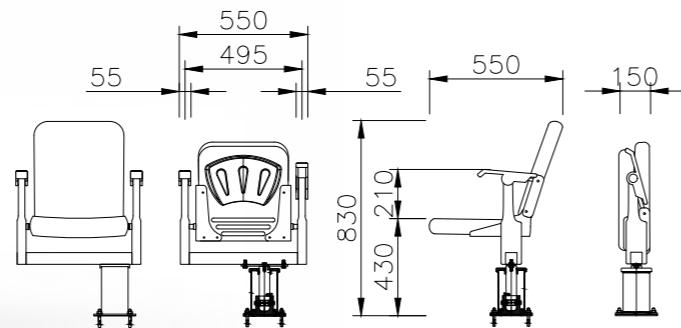

### Color option



<b>Material</b>	Seat, back: High Density Polyethylene (HDPE)
	Armrest: Polycarbonate (PC)
	Bracket: Steel
	Frame: Aluminum die casting
<b>Size (mm)</b>	W495 x D538 x H830
<b>Finish</b>	Powder coating
<b>Molding type</b>	Blow molding
<b>Application</b>	Stadium, Arena

NSC 2051 is a spring fold spectator seat for the disabled.

It can make 90 degree anticlockwise rotation for easier access (patent).



# NSC 4010

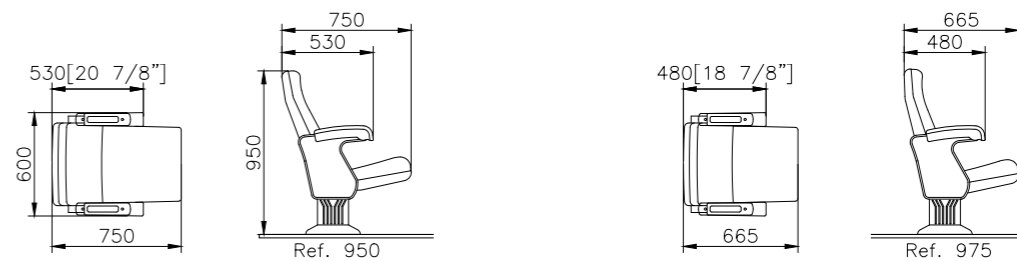

<b>Material</b>	Seat, back, armrest, leg: Copolymer polypropylene Cushion: Polyurethane foam
<b>Size (mm)</b>	W600 x D750 x H950
<b>Finish</b>	Artificial leather upholstery
<b>Molding type</b>	Seat, back, armrest, leg: injection molding
<b>Application</b>	Stadium, Arena

NSC 4010 a spring fold spectator seat. It is upholstered with weather resistant artificial leather. Polyurethane foam molded seat and back give maximum comfort to the user. Tablet and cup holder option add more convenience. NSC 4010 is a popular choice for VIPs and VVIPs.

# Options for non tip up seats

## Rail System

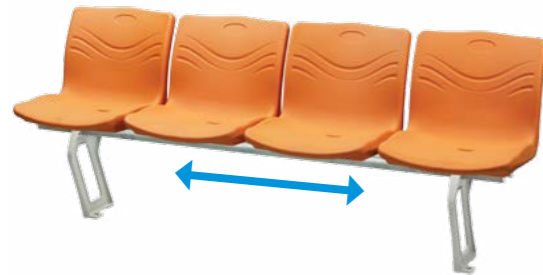

Rail system allows flexible arrangement

## Mounting option



Epoxy (E)



Steel bracket (S)



Floor mount (FS)



Floor mount (FA1)

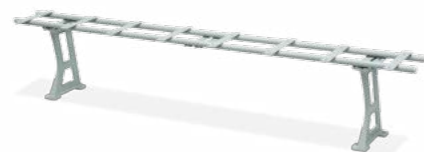

Floor mount (FA2)



Wall mount (W)

## Color option



## Seat number



Polycarbonate by 3M (Sticker)



Aluminum by 3M (Sticker, Screw)

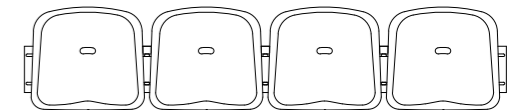
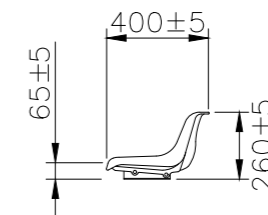
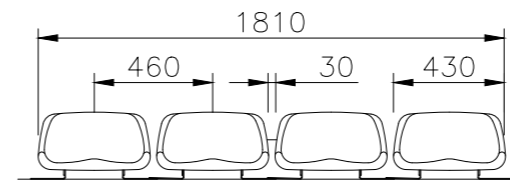

# NSC 1002

Material	Seat: HDPE
	Frame, Leg: Aluminum die casting, Steel
Size (mm)	S: W430 X D350 X H270
	FA1: W430 X D400 X H593
	FS: W430 X D370 X H625
	W: W430 X D400 X H530
Finish	Powder coating
Molding type	Injection molding
Application	Stadium, Arena

NSC 1002 an injection molded, non tip up seat whose seat center can be adjusted between 430–500mm.

By using three different types of understructures, the seat can be installed either on the floor or wall.

NSC 1002 is a popular choice for general spectators.

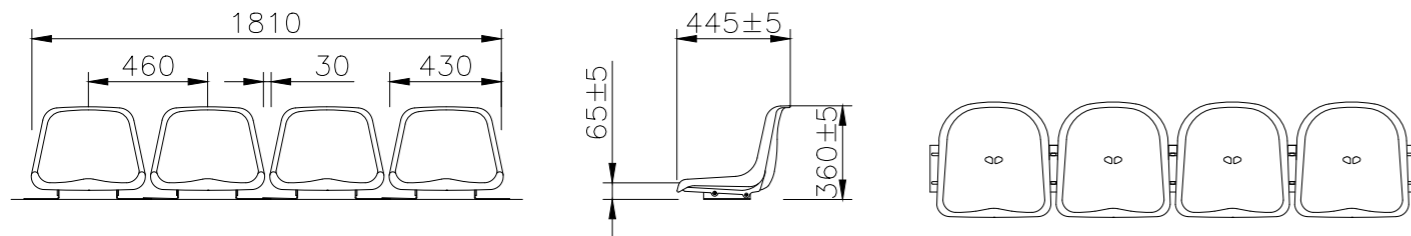

## NSC 1006

Material	Seat: HDPE
	Frame, Leg: Aluminum die casting, Steel
Size (mm)	S: W430 X D395 X H375
	FA1: W430 X D445 X H690
	FS: W430 X D420 X H720
	W: W430 X D445 X H625
Finish	Powder coating
Molding type	Injection molding
Application	Stadium, Arena

NSC 1006 an injection molded, non tip up seat whose seat center can be adjusted between 430–500mm.

By using three different types of understructures, the seat can be installed either on the floor or wall.

NSC 1006 is a popular choice for general spectators.

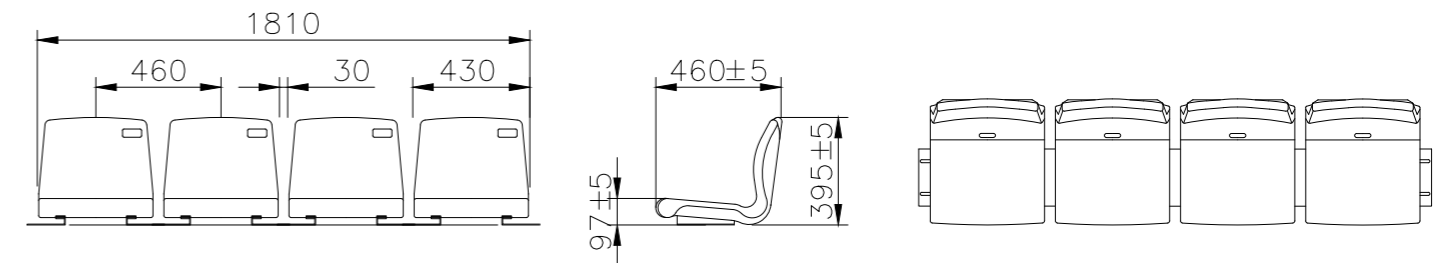

## NSC 1009

Material	Seat: HDPE
	Frame, Leg: Aluminum die casting, Steel
Size (mm)	S: W430 X D490 X H390
	FA1: W430 X D490 X H740
	FA2: W430 X D490 X H745
	W: W430 X D490 X H655
Finish	Powder coating
Molding type	Blow molding
Application	Stadium, Arena

NSC 1009 a blow molded, rail mounted, non tip up seat whose seat center can be adjusted between 430–500mm.

Its ergonomic design as well as hollow space that acts as an air cushion provide maximum comfort to the user.

By using three different types of understructures, the seat can be installed either on the floor or wall.

NSC 1009 is a popular choice for general spectators.

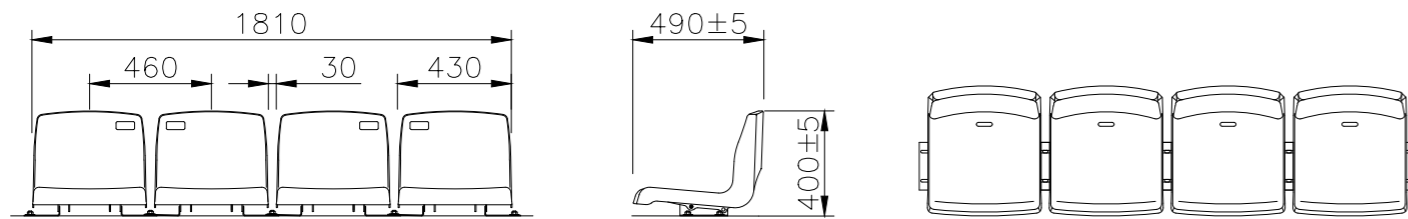

## NSC 1012

Material	Seat: HDPE
	Frame, Leg: Aluminum die casting, Steel
Size (mm)	S: W430 X D490 X H390
	FA1: W430 X D490 X H740
	FS: W430 X D490 X H745
	W: W430 X D490 X H655
Finish	Powder coating
Molding type	Injection molding
Application	Stadium, Arena

NSC 1012 an injection molded, non tip up seat whose seat center can be adjusted between 430–500mm.

By using three different types of understructures, the seat can be installed either on the floor or wall.

NSC 1012 is a popular choice for general spectators.

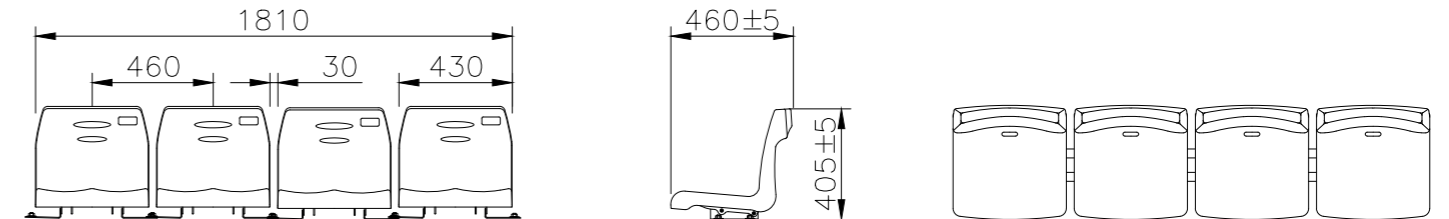

## NSC 1013

Material	Seat: HDPE
	Frame, Leg: Aluminum die casting, Steel
Size (mm)	S: W430 X D460 X H415
	FA1: W430 X D460 X H745
	FS: W430 X D460 X H770
	W: W430 X D460 X H680
Finish	Powder coating
Molding type	Injection molding
Application	Stadium, Arena

NSC 1013 an injection molded, non tip up seat whose seat center can be adjusted between 430–500mm.

By using three different types of understructures, the seat can be installed either on the floor or wall.

NSC 1013 is a popular choice for general spectators.

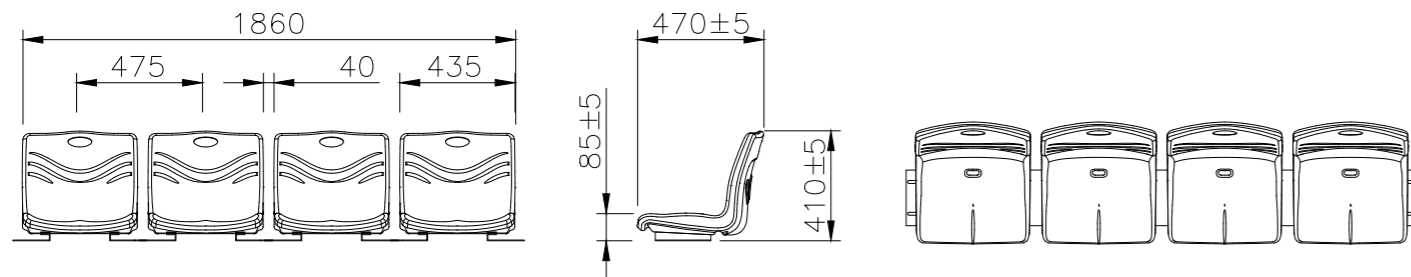

# NSC 1015

Material	Seat: HDPE
	Frame, Leg: Aluminum die casting, Steel
Size (mm)	S: W435 X D470 X H410
	FA1: W435 X D470 X H765
	FA2: W430 X D490 X H745
	W: W430 X D490 X H655
Finish	Powder coating
Molding type	Blow molding
Application	Stadium, Arena

NSC 1015 a blow molded, non tip up seat whose seat center can be adjusted between 435–500mm.

Its ergonomic design as well as hollow space that acts as an air cushion provide maximum comfort to the user.

By using three different types of understructures, it can be installed either on the floor or wall.

NSC 1015 is a popular choice for general spectators.

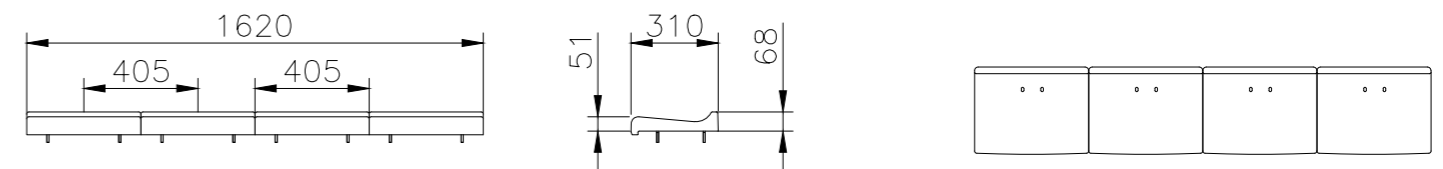

# NSS 1106

Material	Seat: HDPE
	Bracket: Steel plate
Size (mm)	W405 X D310 X H68
Finish	N/A
Molding type	Injection molding
Application	Stadium, Arena

NSS 1106 an injection molded, non tip up seat without backrest whose seat center can be adjusted between 405–500mm.

NSS 1106 is a popular choice for general spectators.



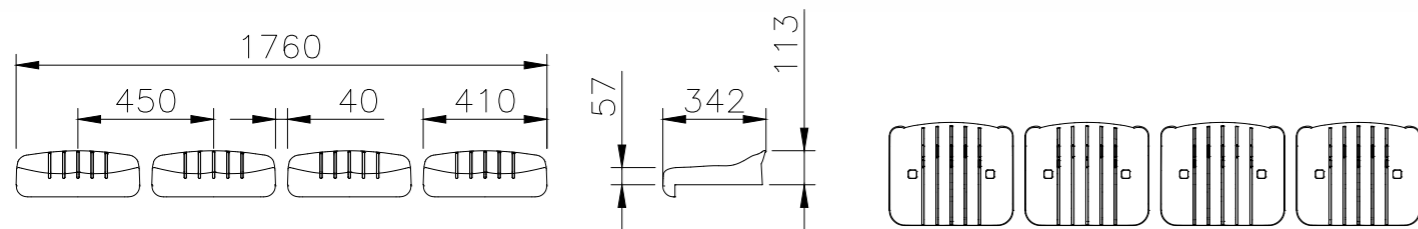

# NSS 1108

Material	Seat: HDPE
	Bracket: Steel plate
Size (mm)	W410 X D342 X H113
Finish	N/A
Molding type	Injection molding
Application	Stadium, Arena

NSS 1108 an injection molded, non tip up seat without backrest whose seat center can be adjusted between 410–500mm.

Its ergonomic design provides comfort to the user.

NSS 1108 is a popular choice for general spectators.

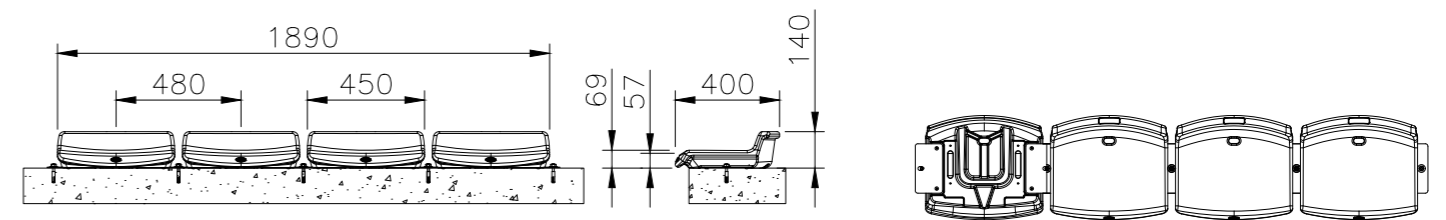

# NSS 1109

Material	Seat: HDPE
	Bracket: Steel plate
Size (mm)	W450 X D400 X H140
Finish	N/A
Molding type	Blow molding
Application	Stadium, Arena

NSS 1109 a blow molded, non tip up seat with mini backrest whose seat center can be adjusted between 450–500mm.

NSS 1109 is a popular choice for general spectators.

# FEATURED PROJECTS

Busan Guduk Stadium (Korea, 8,135 seats)



Incheon Asian Game Main Stadium (Korea, 61,944 seats)



Gochuck Sky Dome (Korea, 16,847 seats)

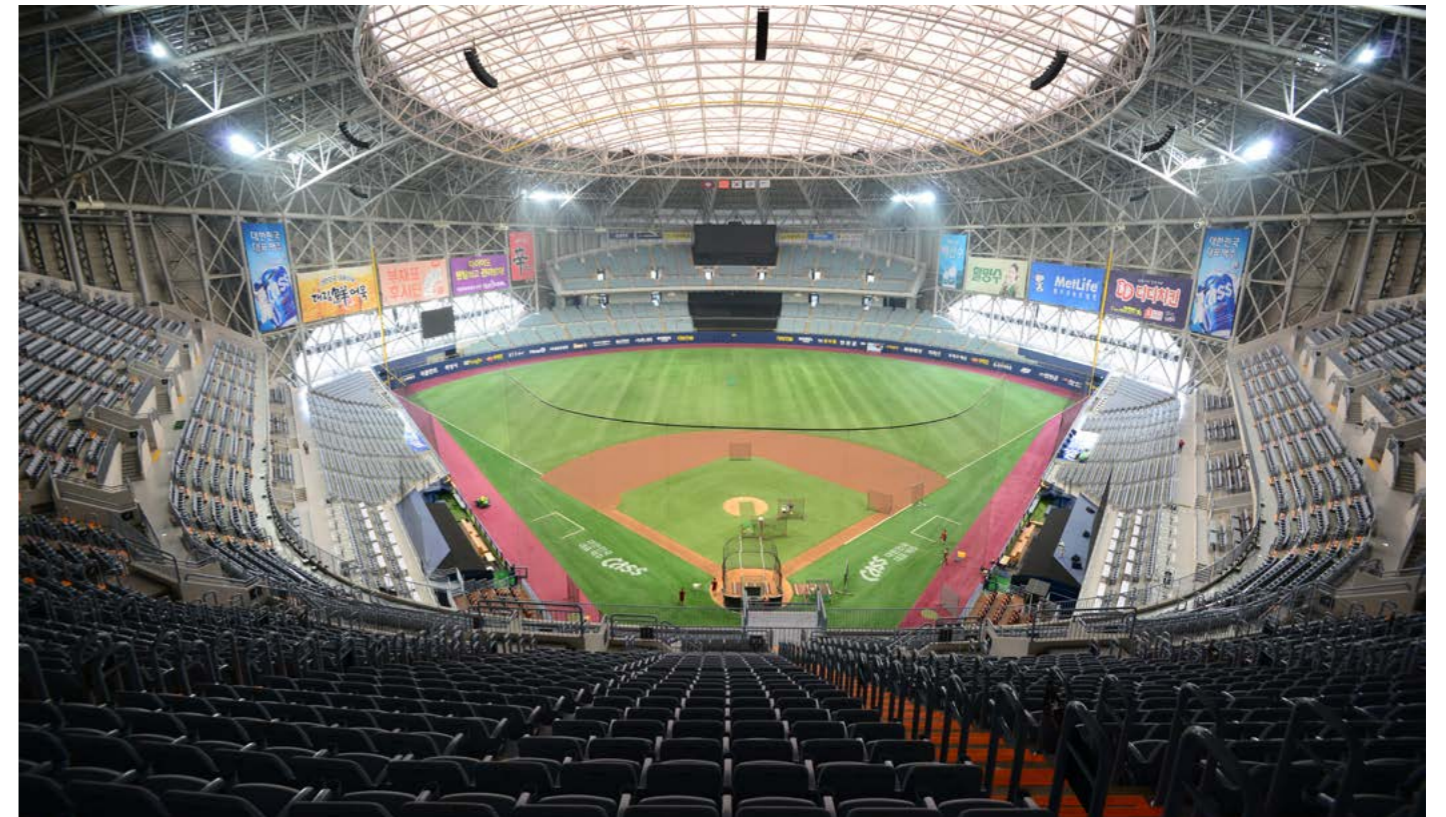

Yangyang Stadium (Korea, 6,500 seats)



Jinju Stadium (Korea, 21,207 seats)



Samsung Lions' Park (Korea, 22,000 seats)



Pohang Baseball Field (Korea, 4,600 seats)



Wonju Stadium (Korea, 15,042 seats)



Hwaseong Arena (Korea, 5,158 seats)



Incheon United Football Field (Korea, 20,467 seats)



Gyeongju Public Stadium (Korea, 12,199 seats)

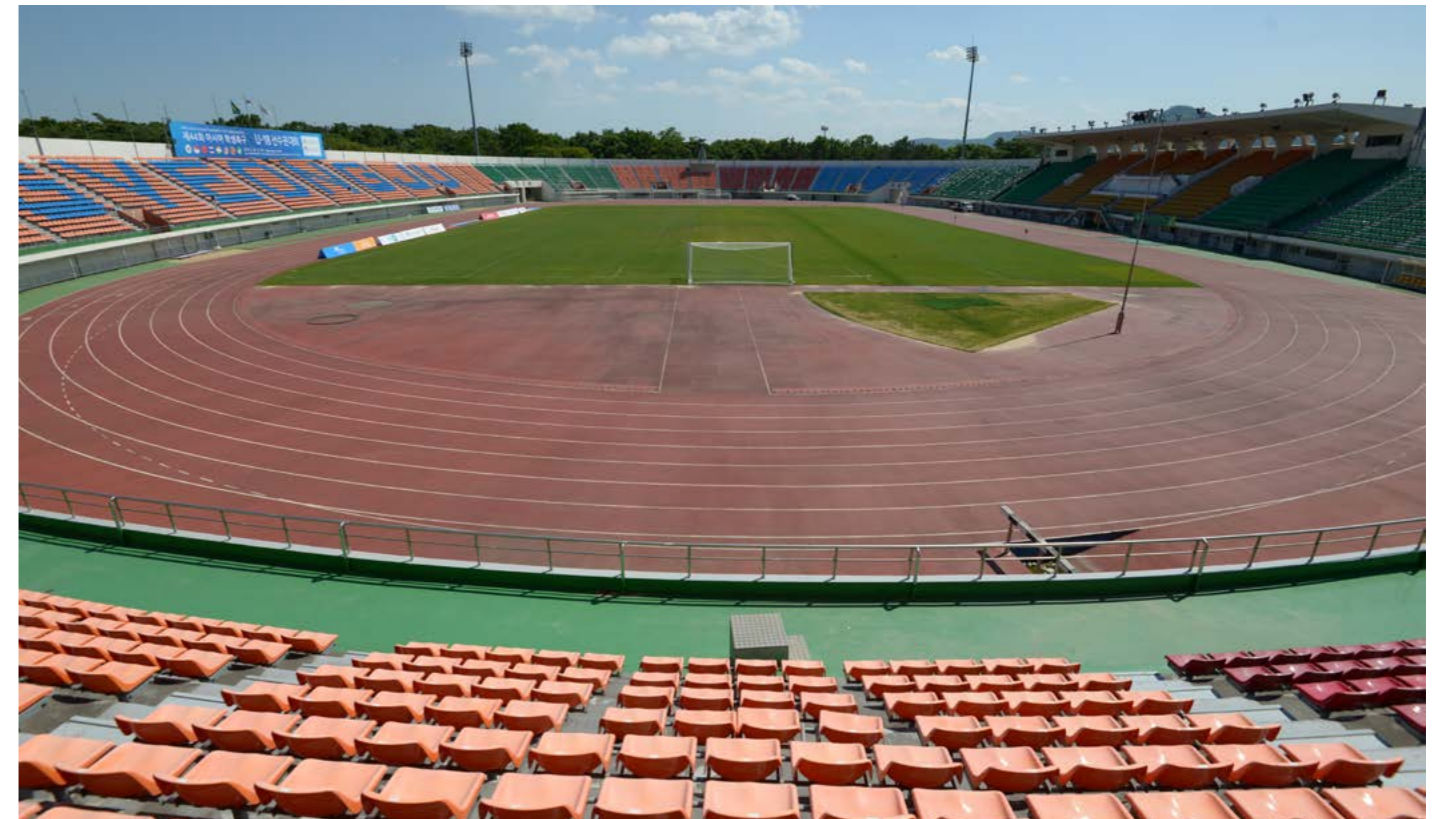

Incheon World Cup Stadium (Korea, 50,256 seats)



Seogwipo World Cup Stadium (Korea, 42,256 seats)



Jeonju World Cup Stadium (Korea, 42,477 seats)



Gwangju World Cup Stadium (Korea, 42,880 seats)



Yeongam F1 (Korea, 16,872 seats)



KASC Sports Hall & Athletics Stadium (Saudi Arabia, 9,344 seats)

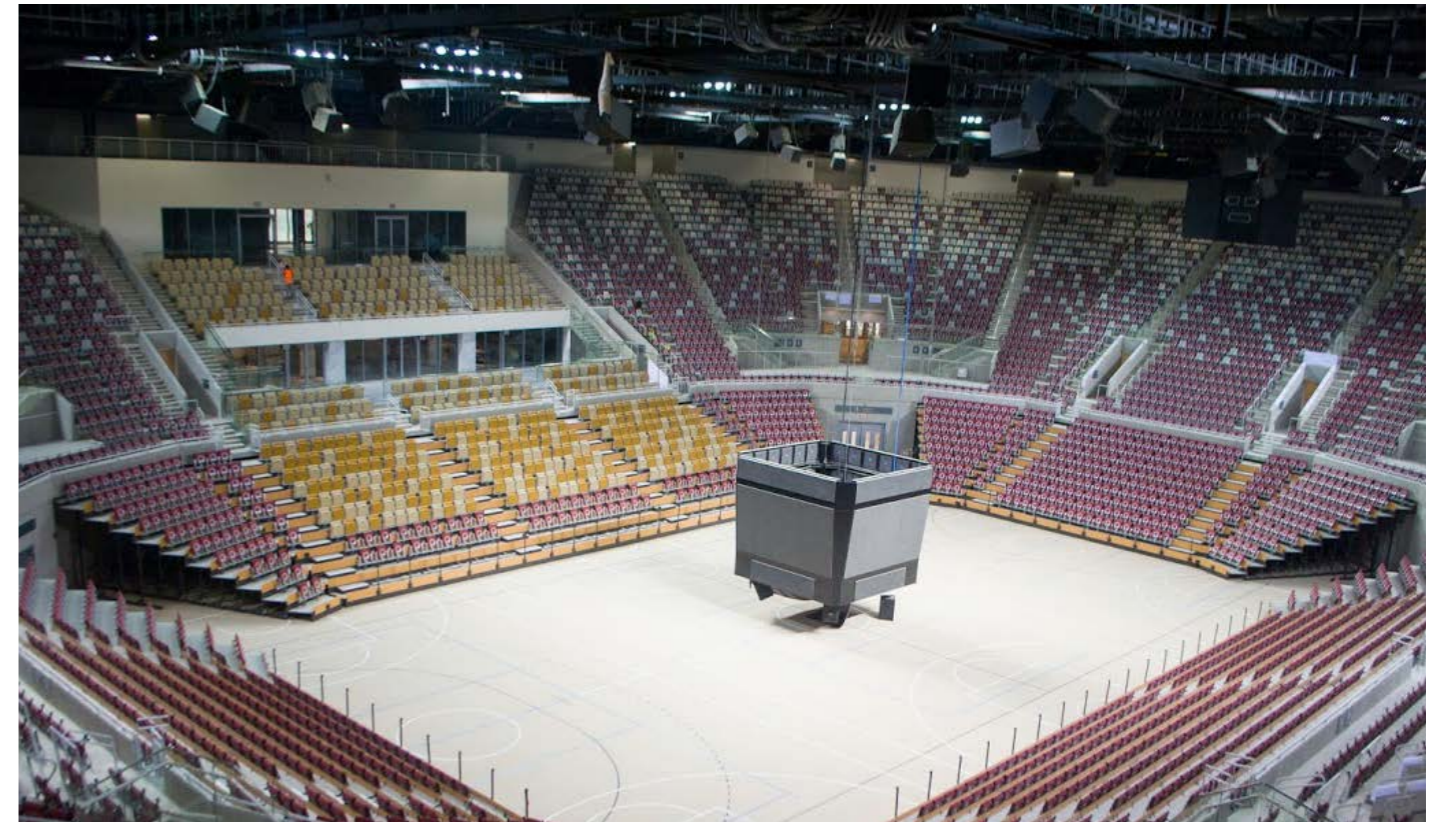

Moonkyung Army Athletic Field (Korea, 19,642 seats)



KASC Sports Hall & Athletics Stadium (Saudi Arabia, 1,086 seats)



# RETRACTABLE SEATING PLATFORM

What is retractable seating platform?

Retractable seating platform, also known as telescopic tribune, is a type of seating that can be folded away to the width of a single row when not in use. It is ideal for multi-purpose or small venues as it can be stored in a portion of the given space. Typical applications include lecture hall, auditorium and arena.

Every venue requires different seating needs. Based on decades of experience with technical expertise, NPC SEATING is capable of providing customized solutions to our clients:

- Design : We use the latest 3D CAD software and customized program to maximize accuracy and minimize human error
- Manufacture: The retractable seating platform is manufactured and assembled at our own facilities by group of highly experienced experts
- Installation : Our dedicated team of installation specialists are committed to comfort and safety of the audience and operator of our product

We offer different types of operation systems

System retraction/withdrawal: Manual, Motorized

Seat folding and unfolding:

- Manual: Operator folds and unfolds each row of seats by hands
- Semi automatic: Each row of seats folds automatically as the system retracts
- Fully automatic: Operator folds and unfolds seats using remote control

Features

- Upper and lower locking system prevent jamming and ensure that the tiers lock safely in place as the system retracts and withdraws
- Guide roller for straight line operation of the system
- Polyurethane wheels ensure no markings or damage on the floor
- Partial withdrawal or retraction of the system

Accessories

- Aisle LED lighting
- Warning light with sound
- Row number
- Side panels or curtains
- Fixed or removable front, side and rear guardrail
- Fire resistant carpet

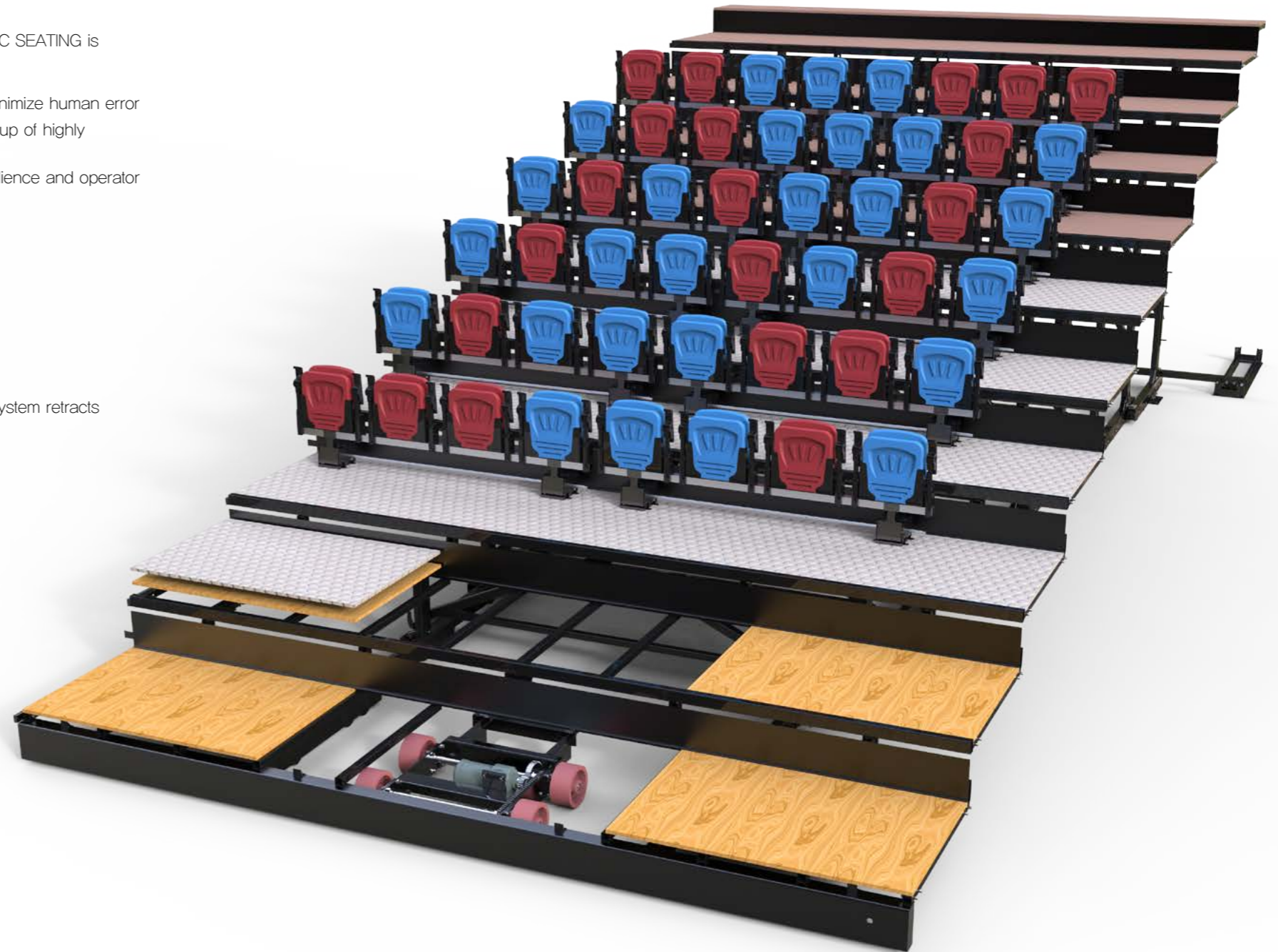

### Seat Fold Mechanism

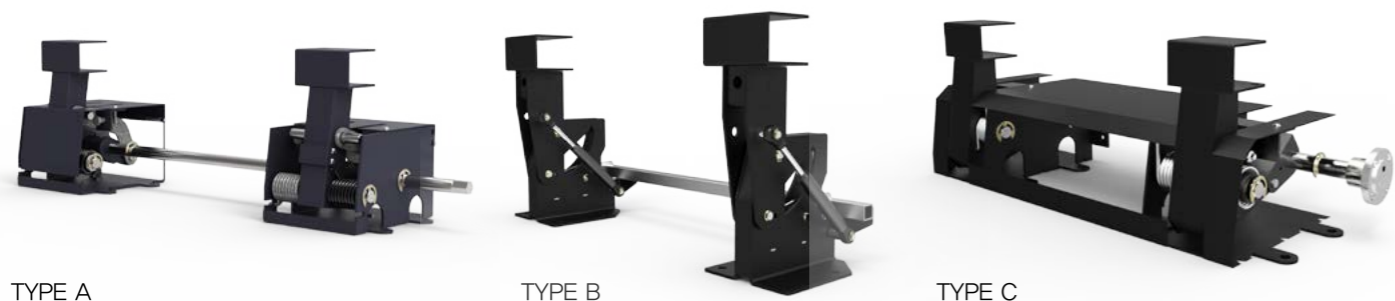

TYPE A

- Spring
- Manual

TYPE B

- Gas strut
- Manual / Semi automatic

TYPE C

- Motor
- Fully automatic by remote control

### Motor: 380V 50HZ, wheels made of rubber



### Accessories



Aisle LED lighting



Aluminum non slip



Steel cup holder

### Upper locking system



### Electronics



Motor control box



Remote control (corded)



Remote control (wireless)



Control box (CE certified)

### Lower locking system

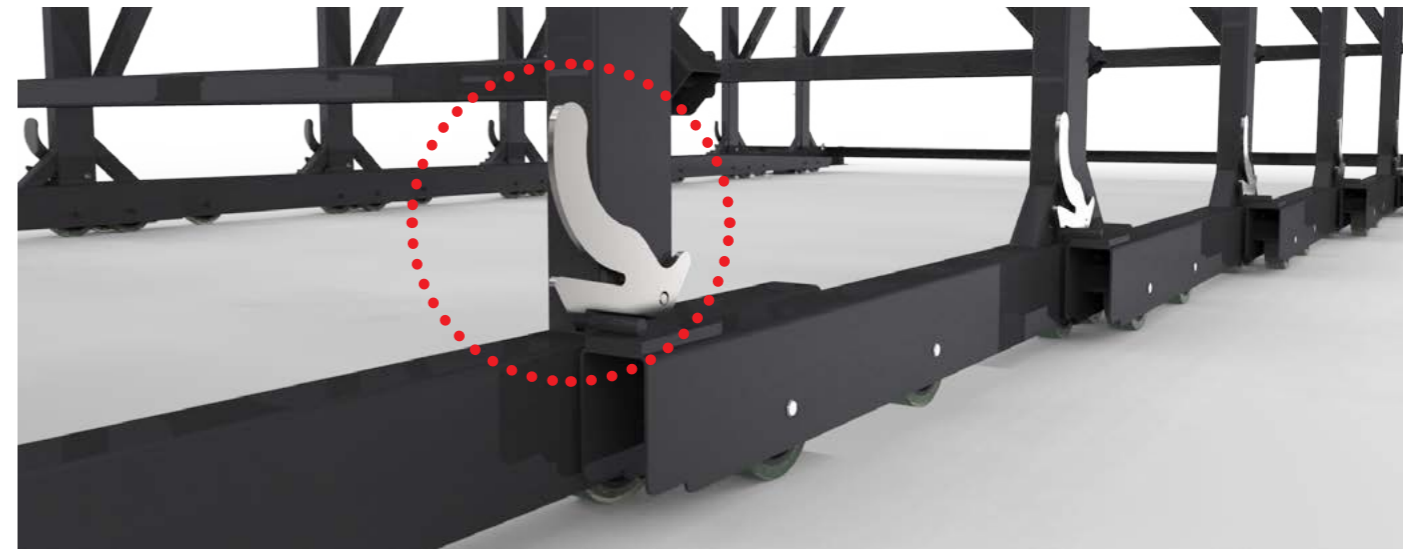

### Steel structure color option



Gray



Dark gray

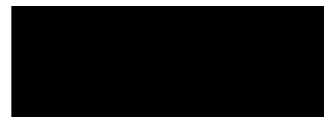

Black



# Platform flooring option

## Carpet



1010



1012



1013



1019

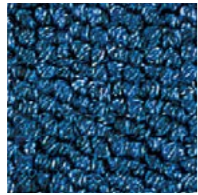

1620



2010

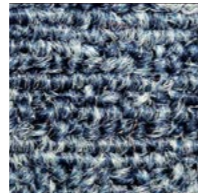

2030



2040



2070

## Linoleum



LC 320



LC 322

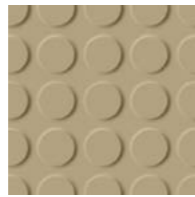

LC 342



LC 361

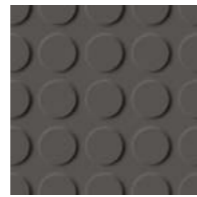

LC 362



LF 322



LF 342



LF 362

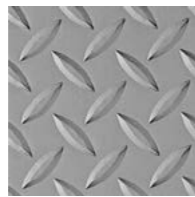

SD 1200



SD 133



SD 233

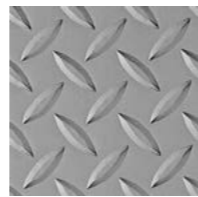

SD 263

## Deco-tile



CRE 1001



CRE 1002

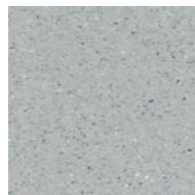

CRE 1003

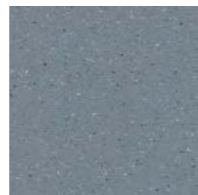

CRE 1004

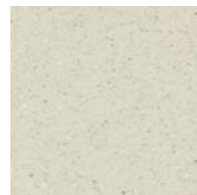

CRE 1005

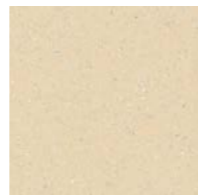

CRE 1006



CRE 1007



CRE 1008

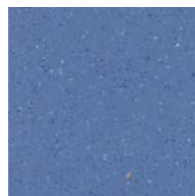

CRE 1009



CRE 1010

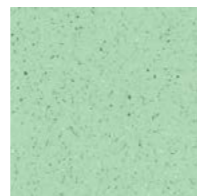

CRE 1011

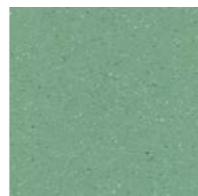

CRE 1012

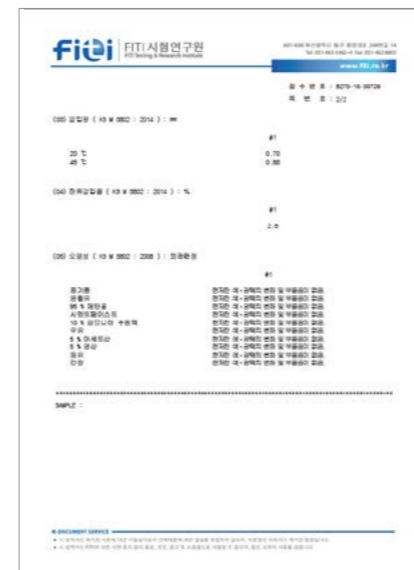
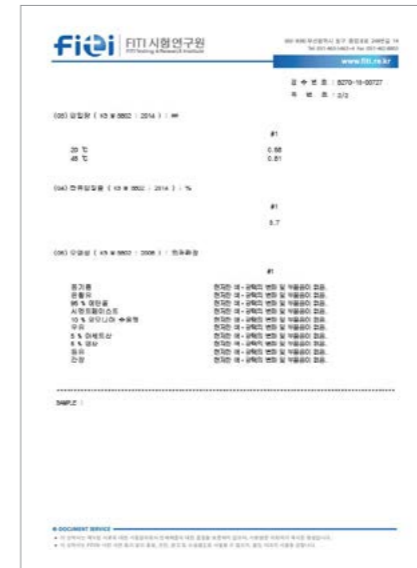

# Fabric color option for seat

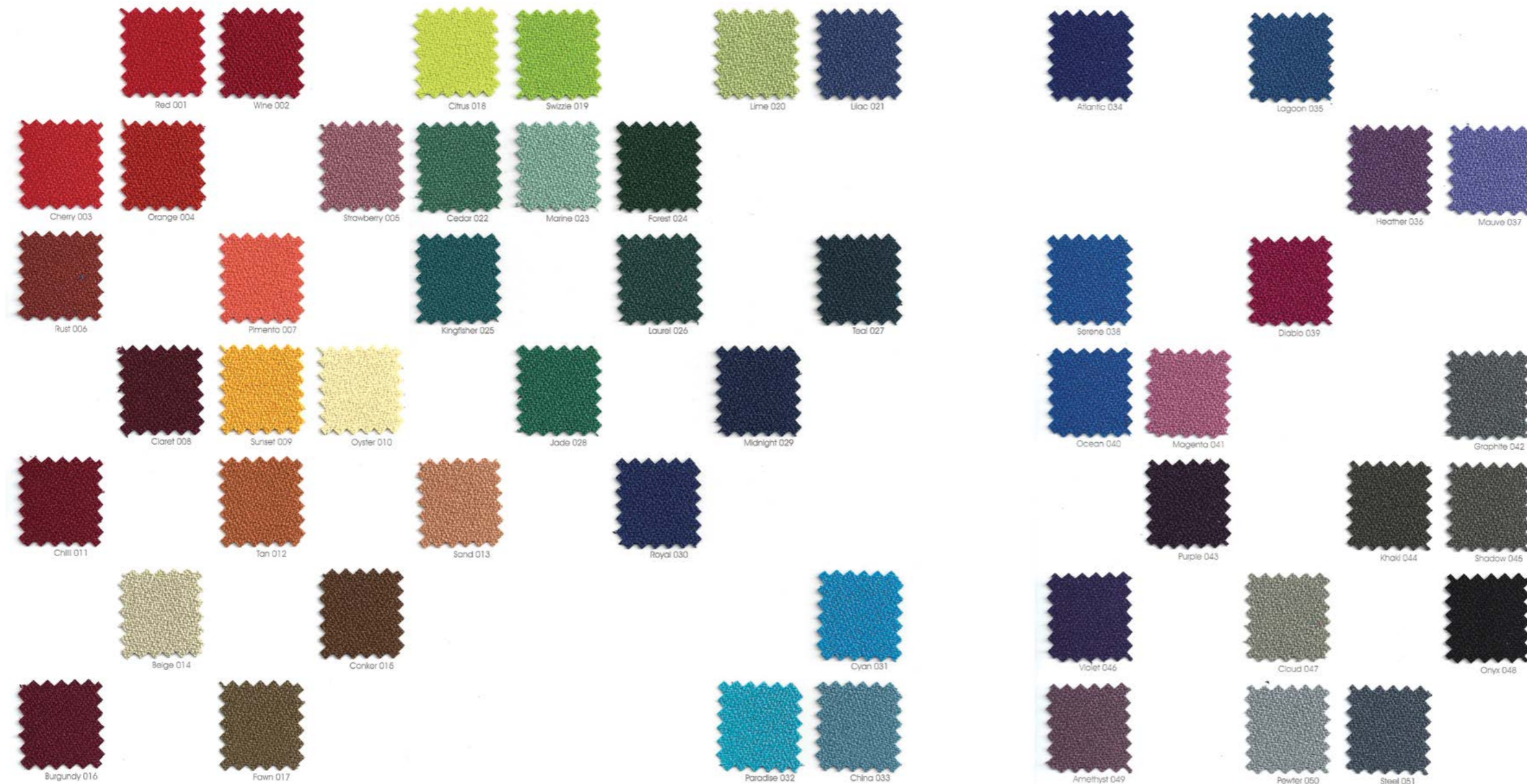

## Specification

- Flammability: BS 5853:2006 (Source 5)
- Abrasion resistance: ISO 12947-2:2014 (Martindale methods 200,000 cycles)
- Colorfastness to washing: ISO 105 C06:2014 (Grade 4-5)
- Colorfastness to water: ISO 105 E01:2010 (Grade 4-5)
- Colorfastness to perspiration: ISO 105 E04:2010 (Grade 4-5)
- Colorfastness to light: ISO 105 B02:2010 (Xenon-arc lamp, Blue scale Grade 4)
- Colorfastness to rubbing: KS K 0650:2011 (Grade 4-5)
- Tensile strength: KS K 0520:2015 (C.R.E, Grab method N1,100 and 2,200)



# Seats for retractable seating platform

NRB 1000

## Option of NRS series

**NRS 3020** (HDPE seat and back), **NRS 3030** (Wooden seat and back)

- NRS 3020,3030: Floor mount with seat fold mechanism
- NRS 3021, 3031 : Floor mount, mobile
- NRS 3022, 3032: Wall mount
- NRS 3023: Platform mount



NRS 3021



NRS 3022



NRS 3023

## Upholstery option (Fabric)

Option U: Front upholstered



Option F: Fully upholstered



# NRB 1000 series



NRB 1010 (Wood)

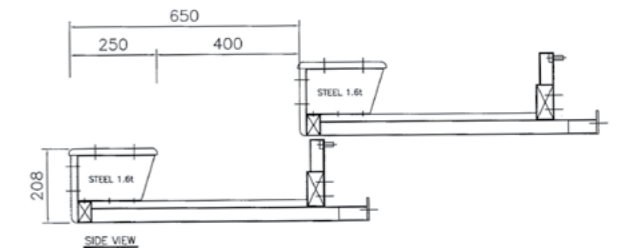

NRB 1020 (HDPE , Blow molded)

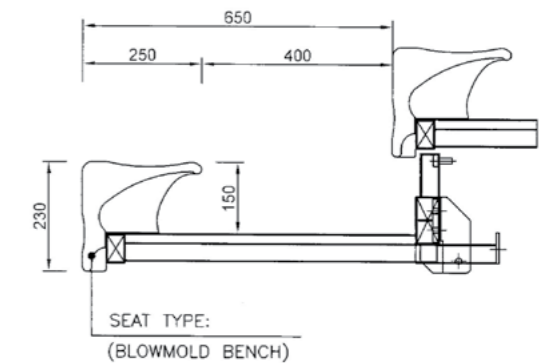

NRB 1030 (Aluminum)

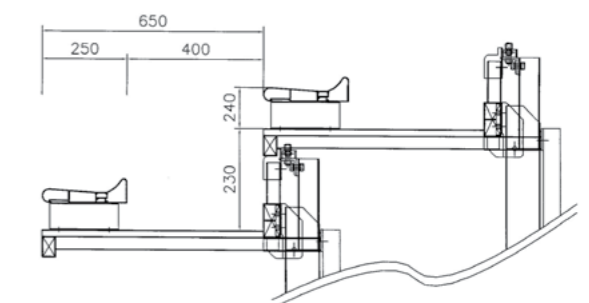



# NRS 3020

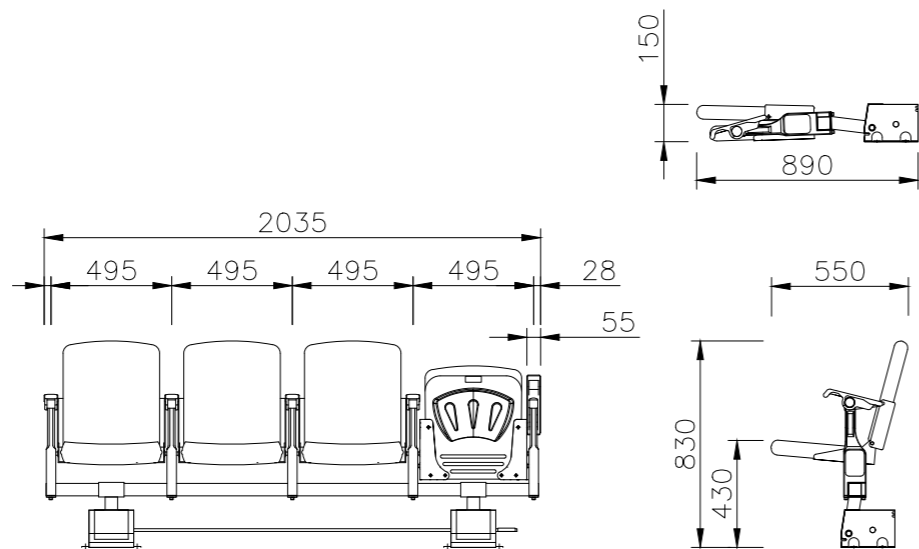

### Color option



Material	Seat, back: High Density Polyethylene (HDPE)
	Armrest: Polycarbonate (PC)
	Frame: Aluminum die casting
Size (mm)	W495 x D550 x H830
	Bracket, leg: Steel
Finish	Frame, leg, bracket: Powder coating
	Upholstery: Fabric
Molding type	Blow molding
Application	Arena, Multipurpose hall

NRS 3020 is a blow molded, spring fold spectator seat with its frame made of aluminum to enhance strength and durability.

NRS 3020 is a great option for retractable seating platform in indoor facilities.

It can be installed as portable or floor fixed.



# NRS 3030

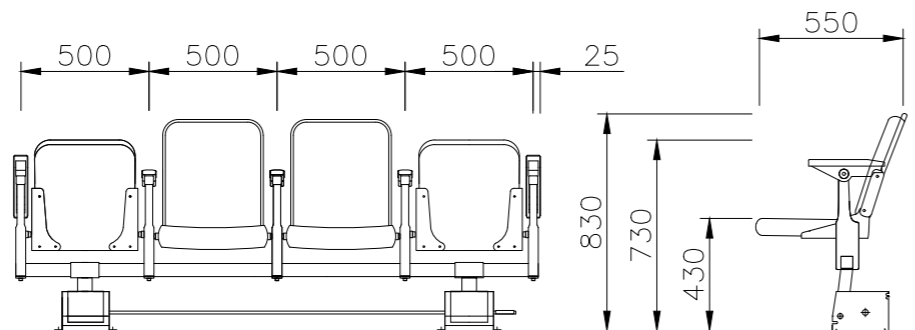

<b>Material</b>	Seat, back, armrest cover: Wood
	Frame: Aluminum die casting
	Bracket: Steel
<b>Size (mm)</b>	Cushion: Polyurethane foam
	W500 x D550 x H830
<b>Finish</b>	Bracket, Frame: Powder coating
	Upholstery: Fabric
<b>Application</b>	Arena, Multipurpose hall, Theater

NRS 3030 is a spring fold spectator seat for retractable seating platform.

Seat and back are made of durable wood and fire resistant / elastic polyurethane foam upholstered by fabric.

# Storage type

## WALL ATTACHED

The last row of seats is fixed to the wall / floor and the stand moves toward the wall. This is most common type of storage.

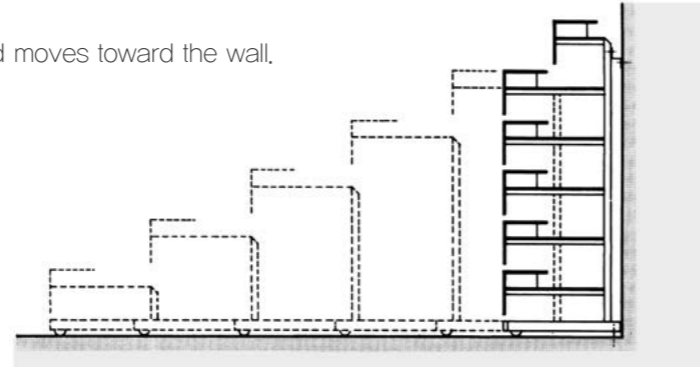

## RECESSED

The stand recedes inside a section of a wall to be in line with the balustrade.

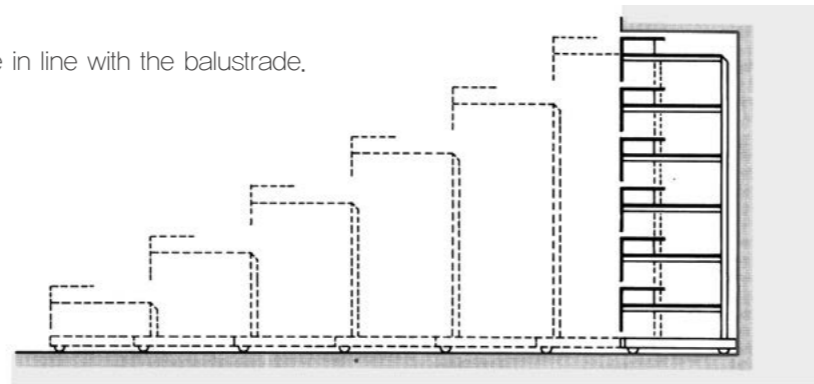

## MOBILE

The platform can be moved to other places by a hand pallet jack.

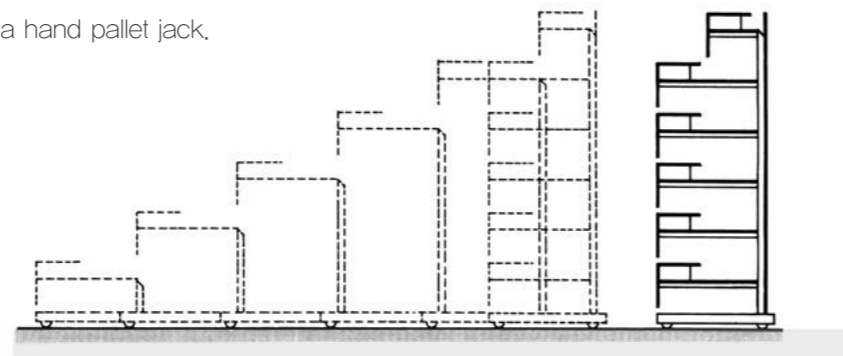

# Dimensions

## Seat Type : NRS 3020

(mm)

Classification	Minimum	Typical	Maximum
A	850	900	1000
B	300	350	450
C	430	450	430
D	550	550	550
E	230	250	500

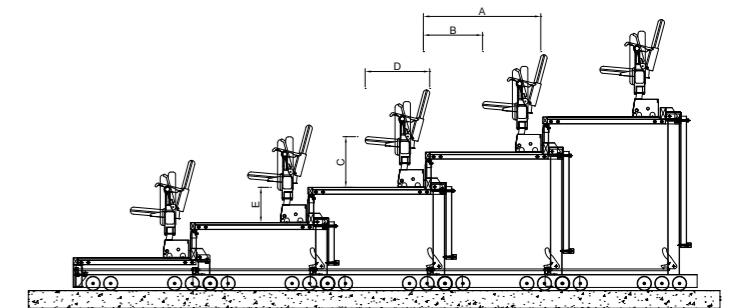

## Seat Type : NRS 3023

(mm)

Classification	Minimum	Typical	Maximum
A	850	900	1000
B	300	350	450
C	430	430	450
D	550	550	550
E	230	300	330

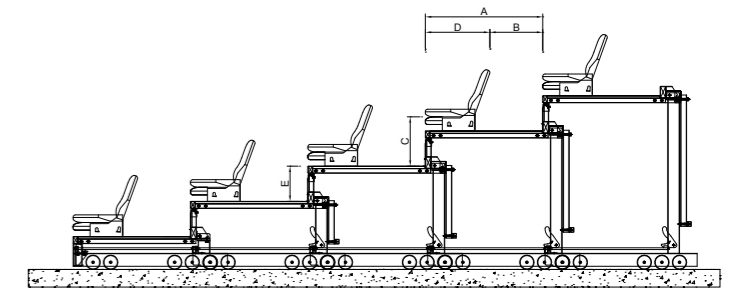

## Seat Type : NRB 1020

(mm)

Classification	Minimum	Typical	Maximum
A	600	650	900
B	350	400	650
C	380	430	450
D	250	250	250
E	230	250	300

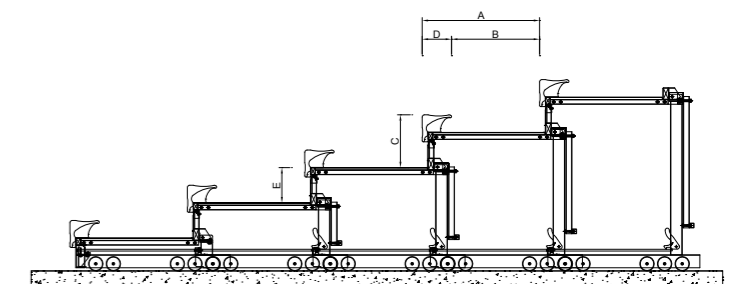

# FEATURED PROJECTS

Daegu College of Education (Korea, 304 seats)

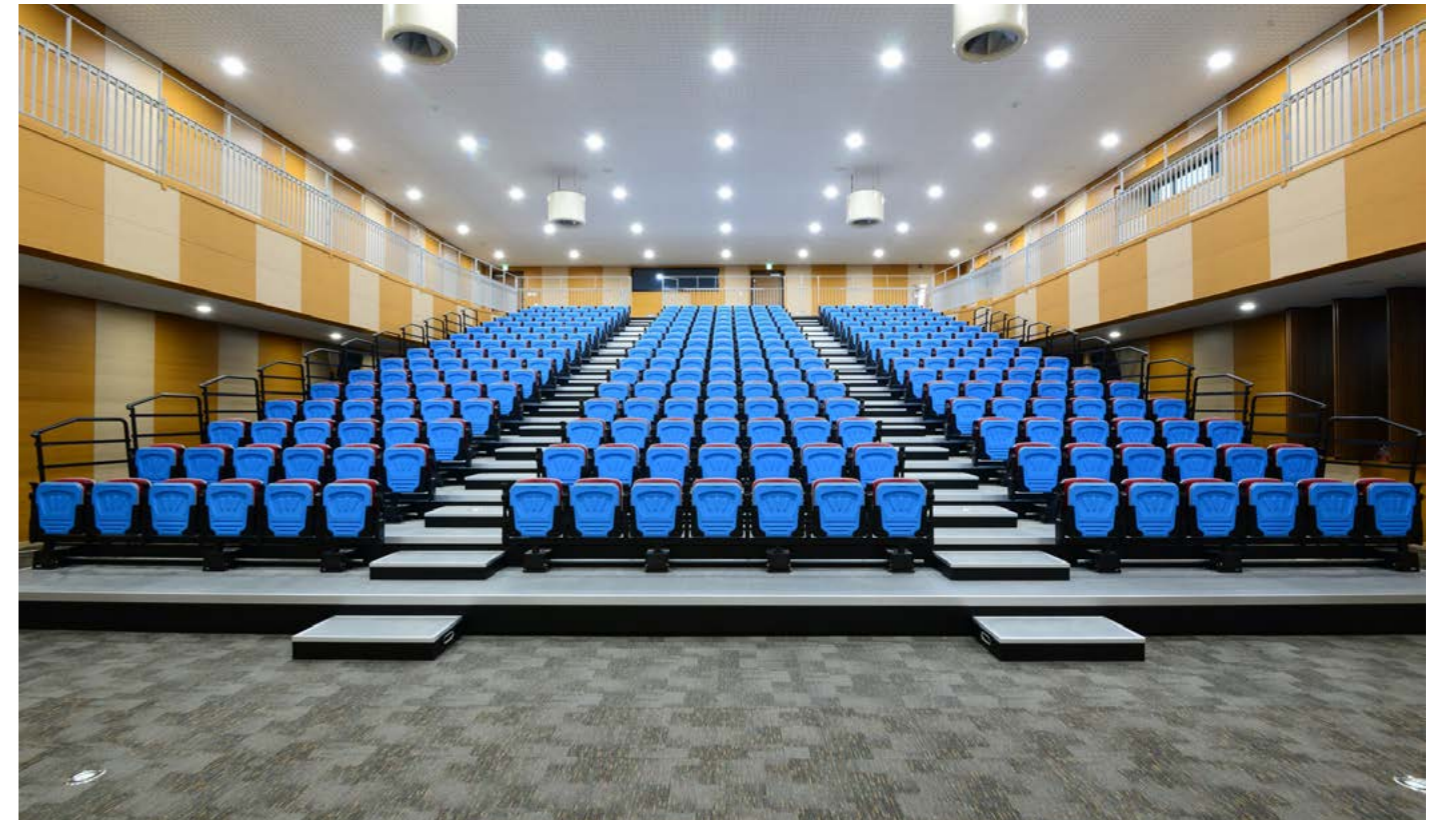

Iksan Cultural Center (Korea, 162 seats)



Andong Gymnasium (Korea, 1,288 seats)

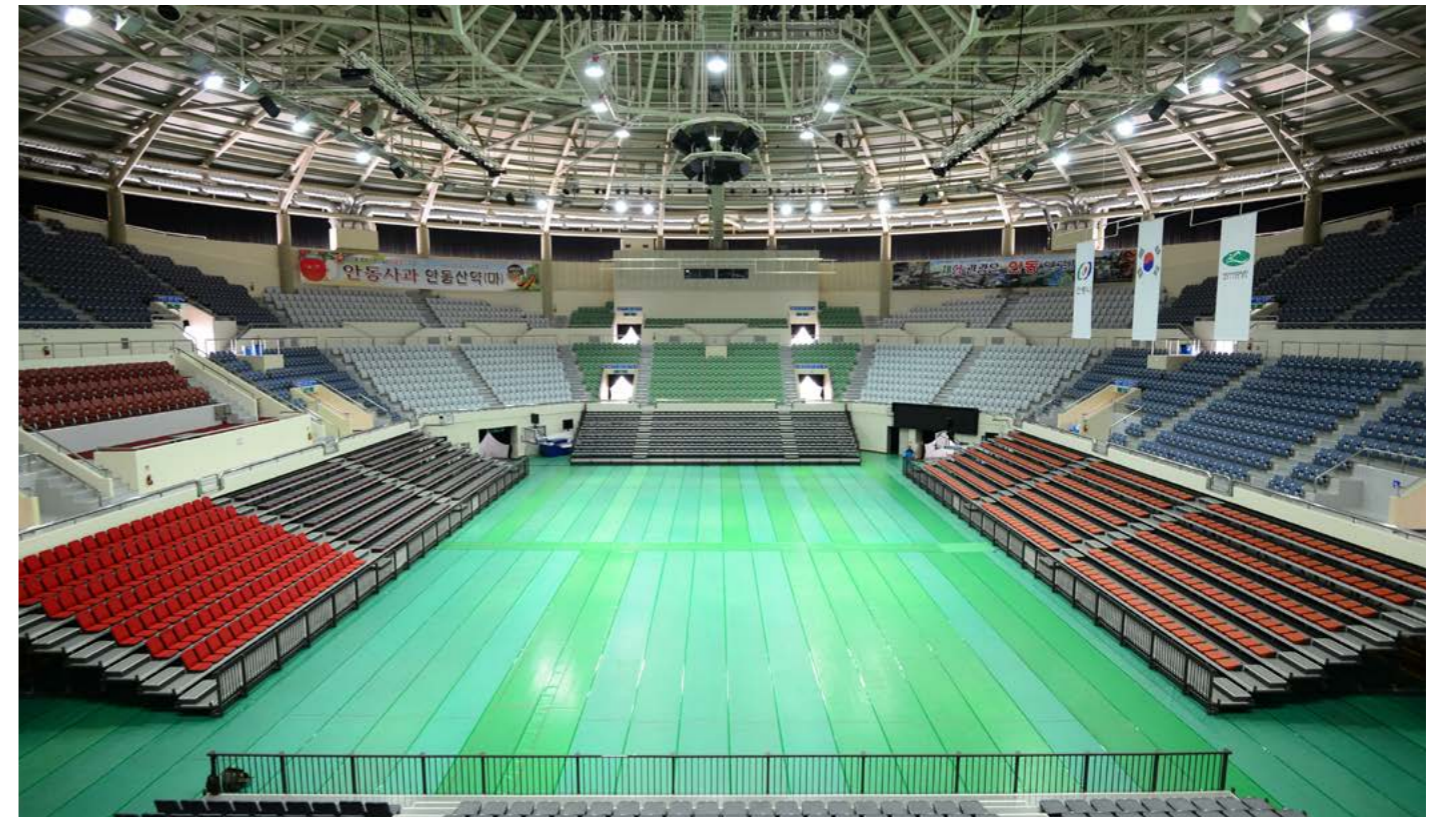

Banwol High School (Korea, 158 seats)



Incheon Samsan Arena (Korea, 903 seats)



Korea University (Korea, 4,811 seats)



Posco Pohang Gym (Korea, 644 seats)





Goyang City Arena (Korea, 1,812 seats)



Southland Stadium (New Zealand, 3,500 seats)

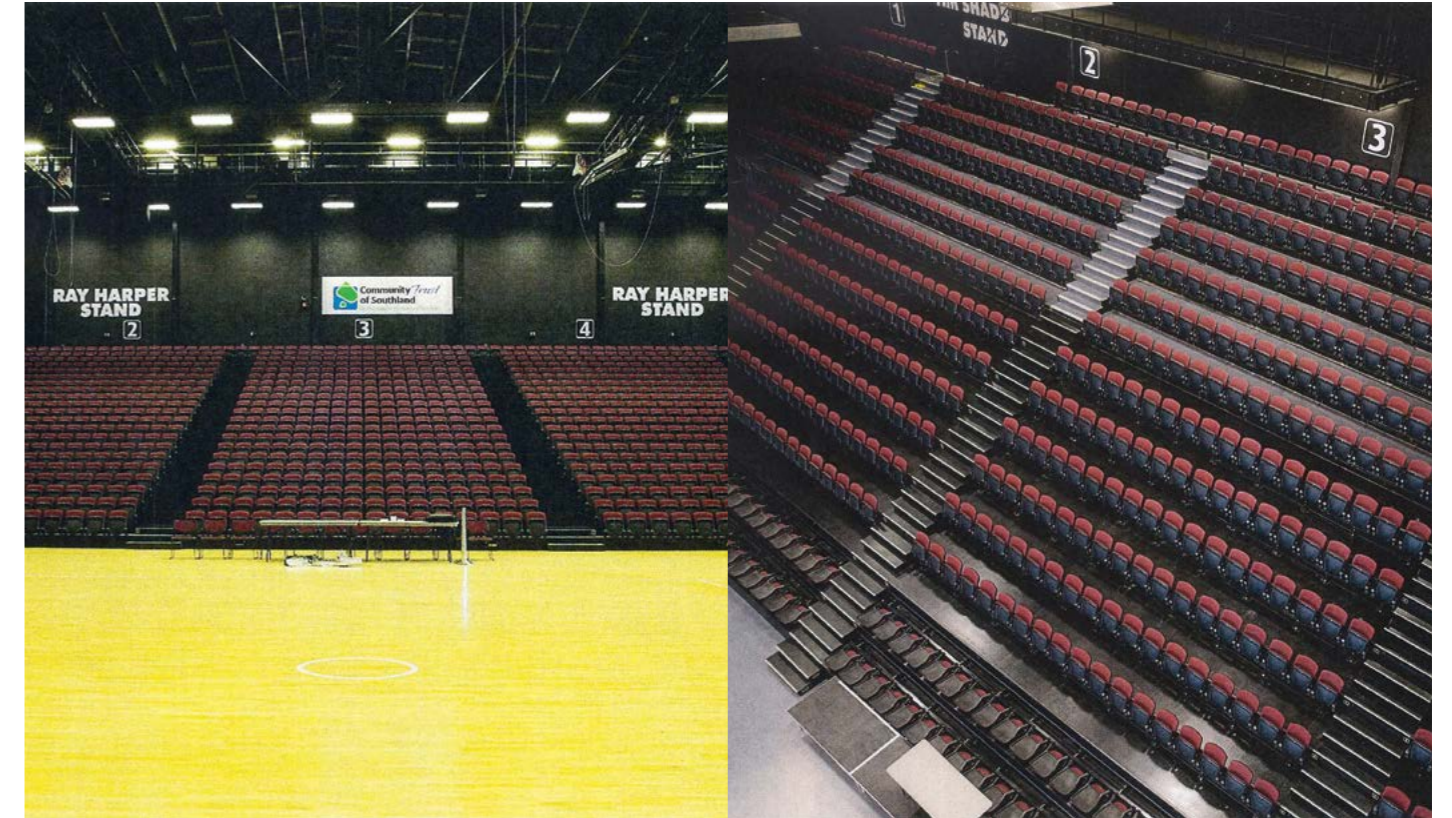

Anderson Creek (Australia, 440 seats)



JECC (India, 760 seats)



Aquinas College (Australia, 360 seats)



Emmaus College (Australia, 286 seats)



Diamond Creek (Australia, 916 seats)

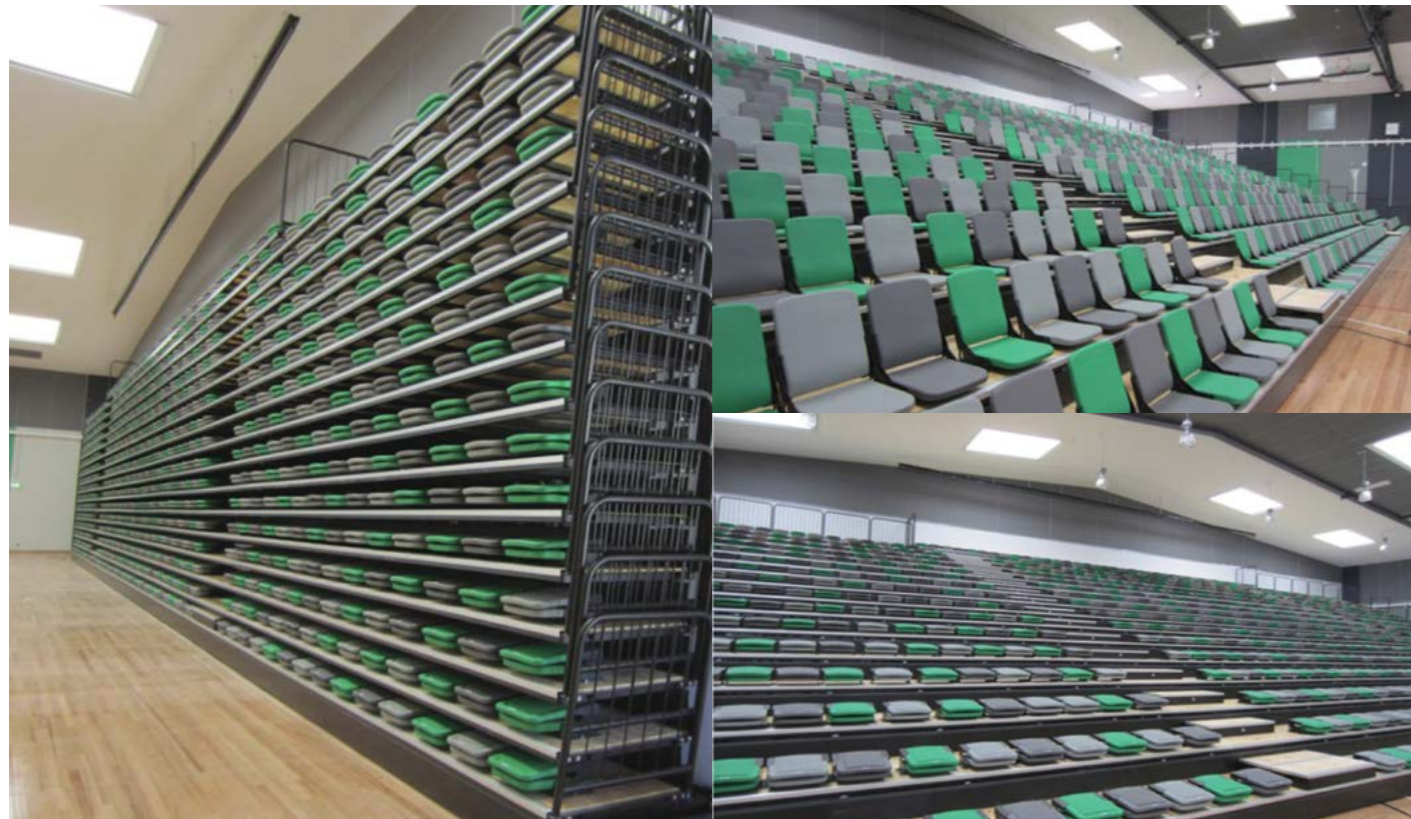

Kardinia College (Australia, 1,593 seats)

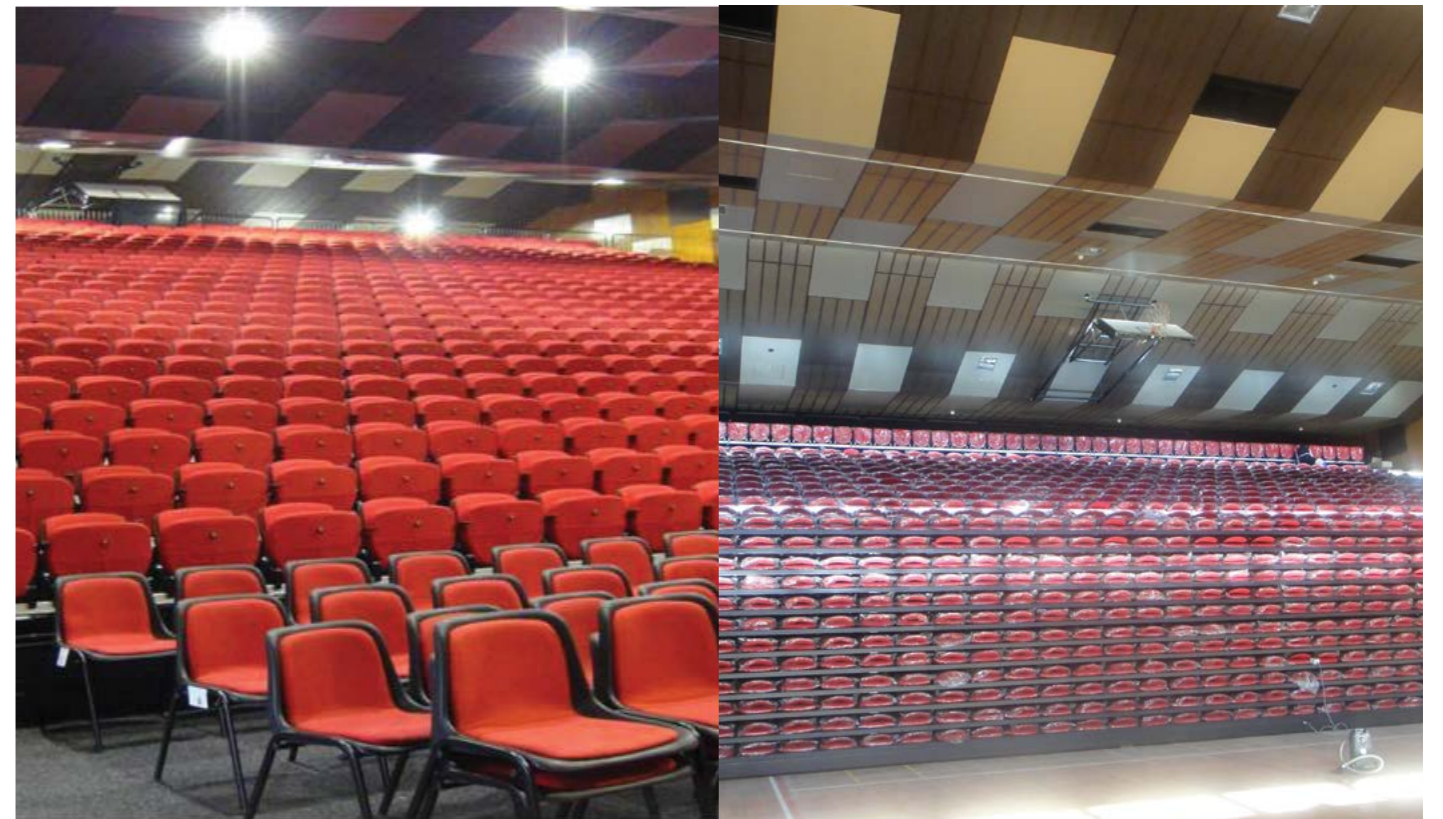

Mackillop College (Australia, 462 seats)



Taurama Aquatic Center (Papua New Guinea, 901 seats)



Sir John Guise Indoor Stadium (New Zealand, 1,104 seats)



United Interior (Kuwait, 650 seats)

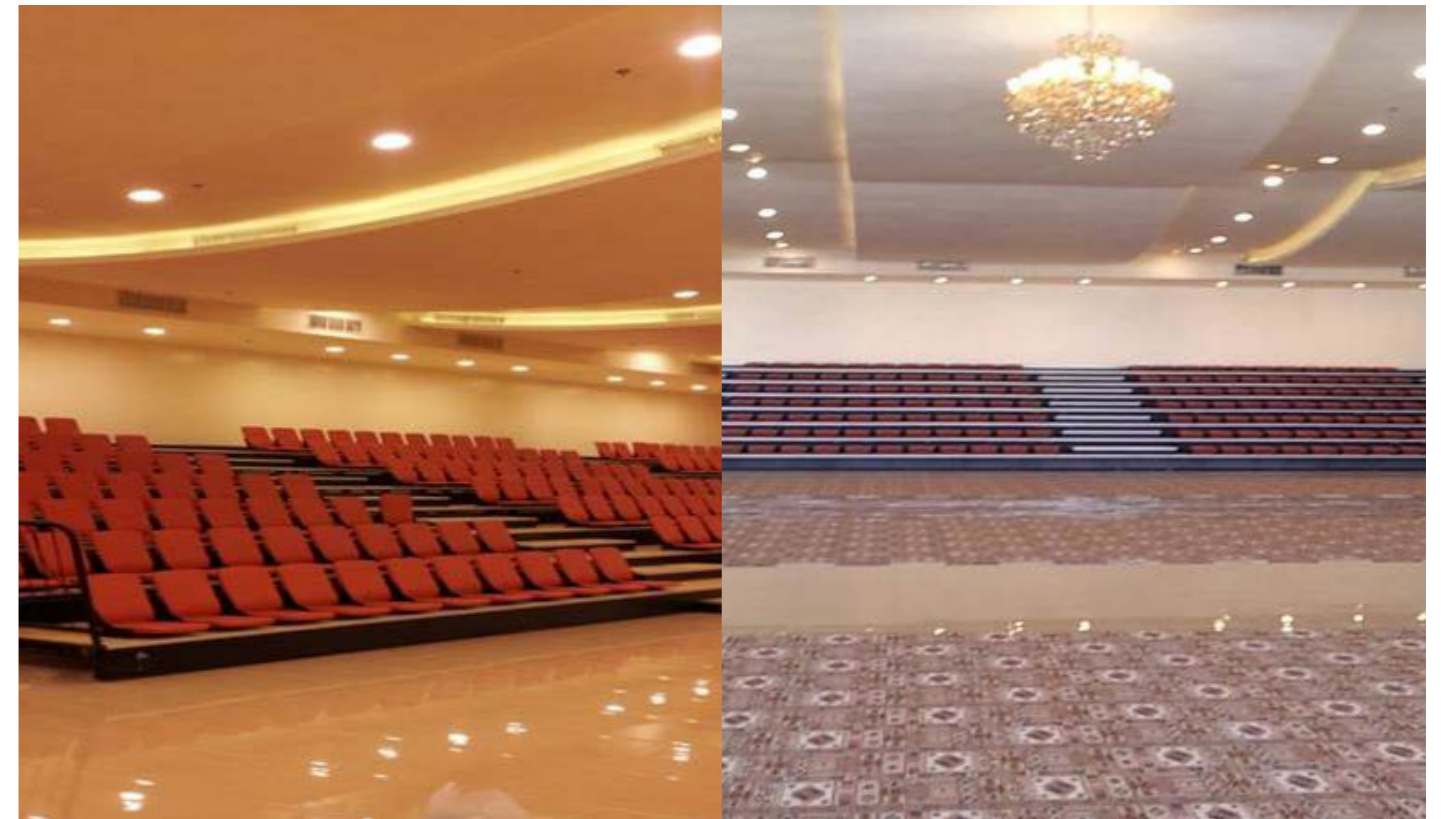

# GRAND STAND / BLEACHER

Grandstand and bleacher are temporary or permanent steel structures for spectators at sports stadiums.  
NPC SEATING's cost effective and versatile structures can be custom built to meet your exact requirements.  
Not only our efficient modular system allows fast installation, but it guarantees safety, stability and comfort.

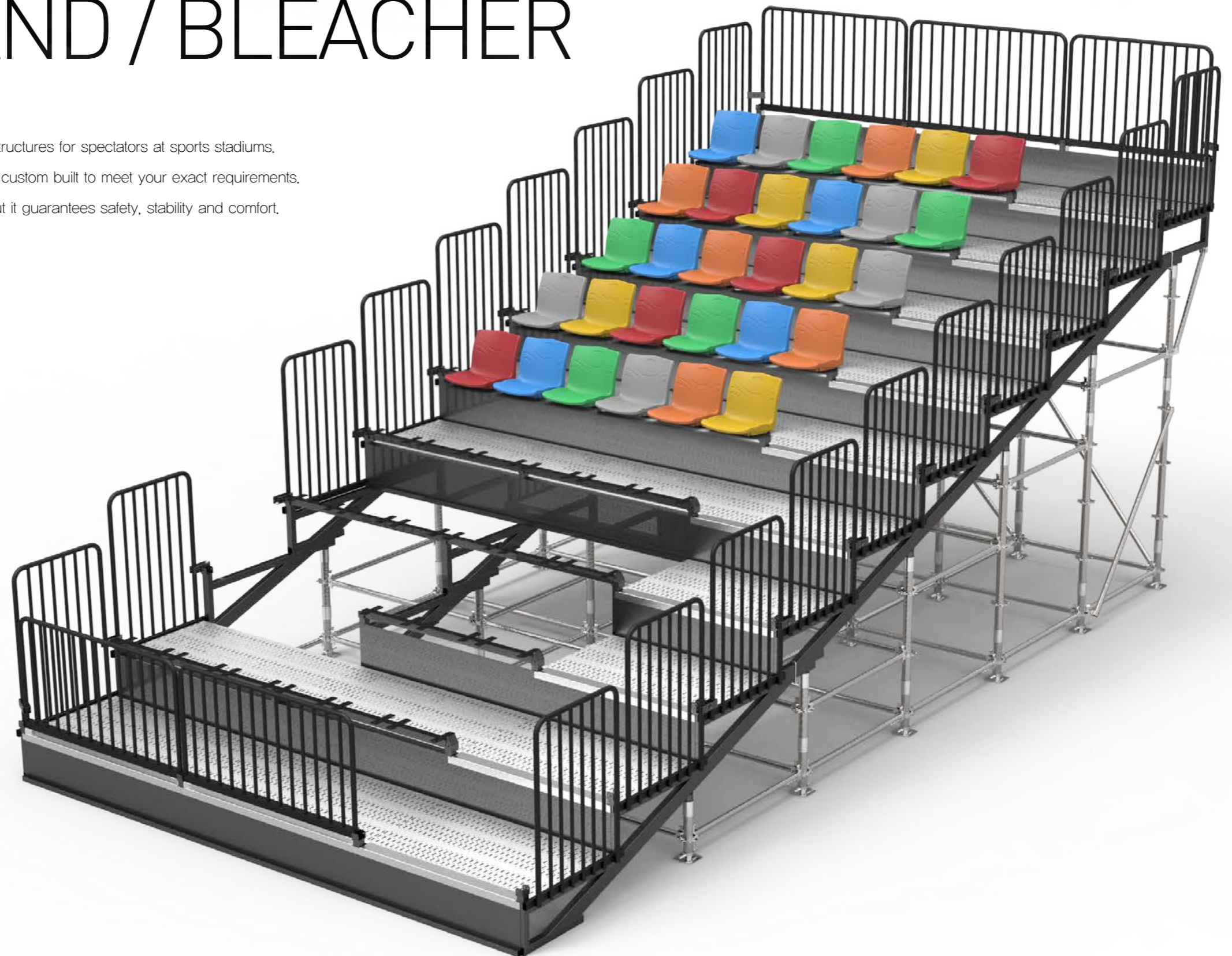



## NPC 2000

Temporary / portable bleacher. Safe, stable and easy to install for indoor and outdoor use.

Made of either aluminum or wood. Size can be customized. Wheels can be attached for ease of movement.

Size: W4500 X D950 X H600 (2 rows and 20 seats)



## NPC 3000

Temporary / portable bleacher. Safe, stable and easy to install for indoor and outdoor use.

Made of either aluminum or wood. Size can be customized. Wheels can be attached for ease of movement.

Size: W4500 X D1300 X H800 (3 rows and 30 seats)



## NPC 5000

Temporary stand. Safe, stable and easy to install for indoor and outdoor use.

Made of either aluminum or wood. Size can be customized. Side and rear guard rails can be attached for safety.

Size: W8700 X D2400 X H1600 (3 rows and 50 seats)

### Seats for NPC 5000



NSC 1002



NSC 1006



NSC 1009



NSC 1012



NSC 1013



NSC 1015



NSS 1106



NSS 1108



NSS 1109

# MULTI PURPOSE HALL

In auditorium, multi purpose hall and theater, NPC SEATING's comfortable NCC series enhance audience's viewing experience during the performance.





# NCC 5010

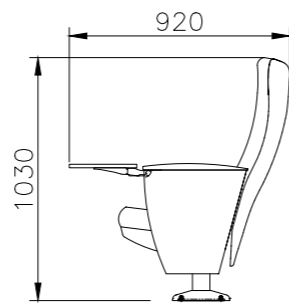
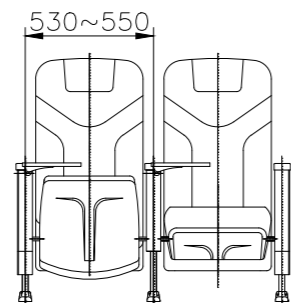

Samsung Raemian Gallery (Korea, 233 seats)

Material	Seat, back: High Density Polyethylene (HDPE)
	Leg: Steel
	Armrest, writing tablet: Wood
Size (mm)	Cushion: Polyurethane foam
	W530-550 x D920 x H1030
Finish	Leg: Powder coating
	Upholstery: Fabric
Application	Multi purpose hall, Auditorium, Theater

NCC 5010 is suitable for auditorium and conference hall.

Seat and back are made of High Density Polyethylene and fire resistant elastic polyurethane foam upholstered by fabric.

Option: Writing tablet



# NCC 5020

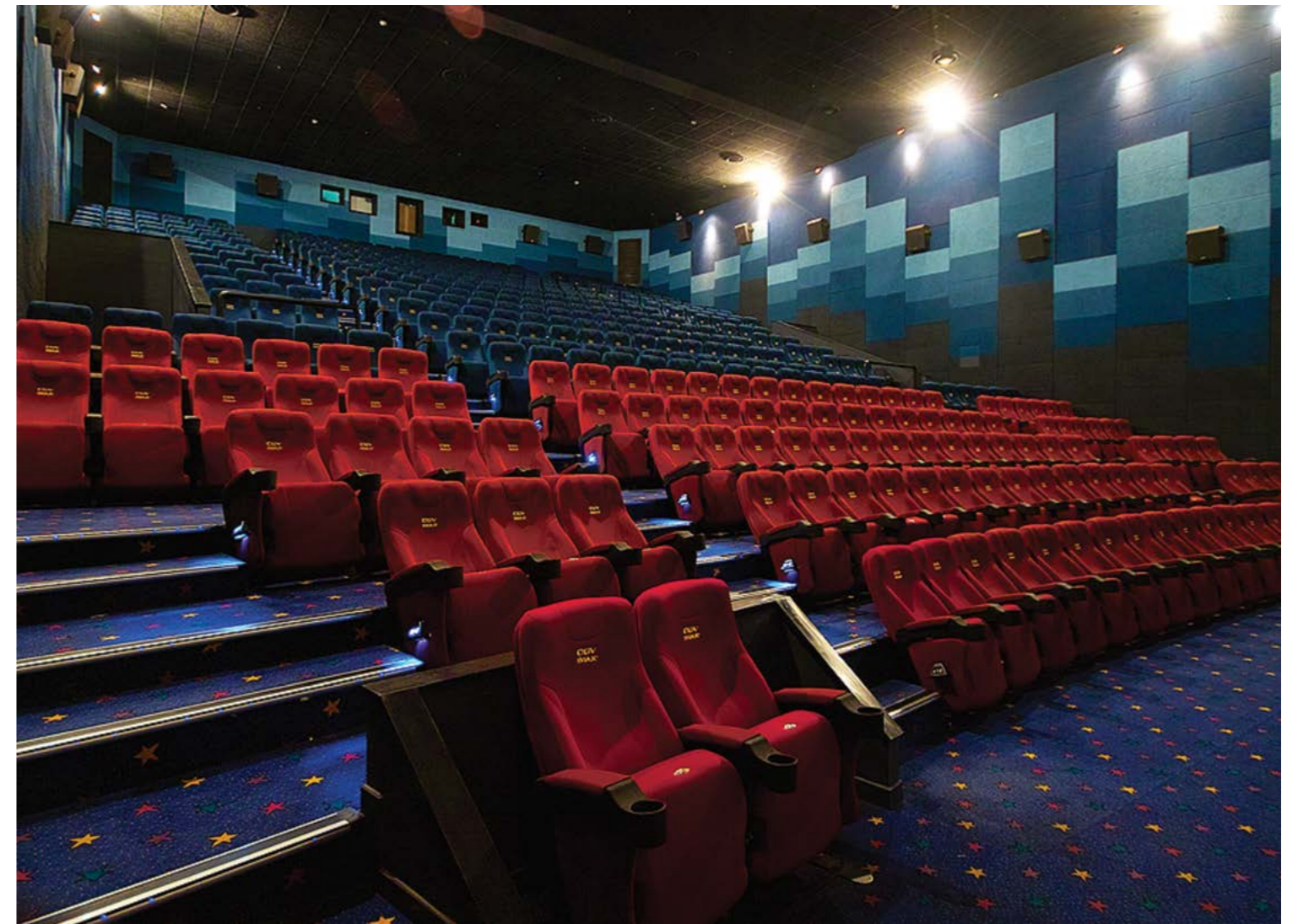
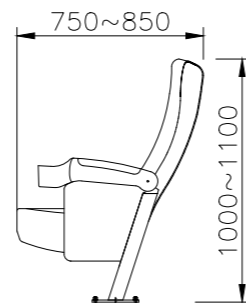
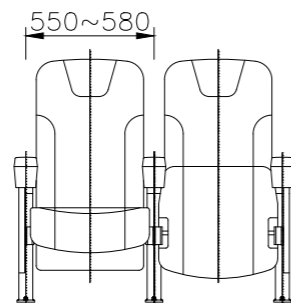

CGV Incheon Starium (Korea, 291 seats)

Material	Seat, back, armrest: High Density Polyethylene (HDPE)
	Leg: Steel
	Writing tablet: Wood
Size (mm)	Cushion: Polyurethane foam
	W550-580 x D750-850 x H1000-1100
Finish	Leg: Powder coating
	Upholstery: Fabric
Application	Multi purpose hall, Auditorium, Cinema

NCC 5020 is great option for cinema and auditorium.

Seat and back are made of High Density Polyethylene and fire resistant / elastic polyurethane foam upholstered by fabric.





# NCC 5030

Government Complex Sejong (Korea, 624 seats)

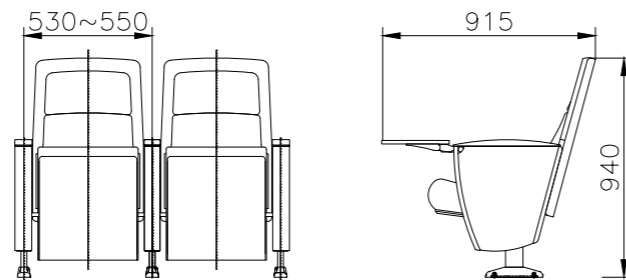

Material	Seat, back, armrest: Wood
	Leg, frame: Steel
	Writing tablet: Wood
Size (mm)	Cushion: Polyurethane foam
	W530-550 x D915 x H940
Finish	Leg: Powder coating
	Upholstery: Fabric
Application	Multi purpose hall, Auditorium, Theater

NCC 5030 is great option for auditorium and conference hall.

Seat and back are made of durable wood and fire resistant / elastic polyurethane foam upholstered by fabric.

Option: Writing tablet

# BENCH



NDB 901	
Size (mm)	W1820×D475×H415
Seat	HDPE
Frame	Steel
Molding	Injection molding



NDB 902	
Size (mm)	W1820×D475×H415
Seat	HDPE
Frame	Steel
Molding	Injection molding



NB 701	
Size (mm)	W1850×D445×H760
Seat	HDPE
Frame	Aluminum die casting
Molding	Injection molding



NB 806	
Size (mm)	W1780×D445×H780
Seat	HDPE
Frame	Steel
Molding	Injection molding



NB 808	
Size (mm)	W1810×D300×H455
Seat	HDPE
Frame	Steel
Molding	Injection molding



NB 813	
Size (mm)	W1810×D395×H635
Seat	HDPE
Frame	Steel
Molding	Injection molding



NB 702	
Size (mm)	W1850×D400×H615
Seat	HDPE
Frame	Aluminum die casting
Molding	Injection molding



NDB 706	
Size (mm)	W1850×D445×H710
Seat	HDPE
Frame	Aluminum die casting
Molding	Injection molding



NB 712	
Size (mm)	W1850×D480×H745
Seat	HDPE
Frame	Aluminum die casting
Molding	Injection molding



NB 818	
Size (mm)	W1810×D445×H725
Seat	HDPE
Frame	Steel
Molding	Injection molding



NB 821	
Size (mm)	W1880×D560×H770
Seat	HDPE
Frame	Steel
Molding	Injection molding



NB 822	
Size (mm)	W1780×D310×H445
Seat	HDPE
Frame	Steel
Molding	Injection molding

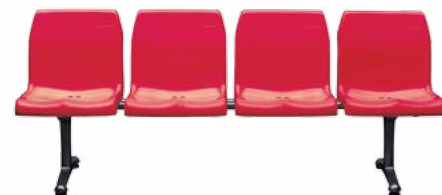

NB 713	
Size (mm)	W1850×D510×H770
Seat	HDPE
Frame	Aluminum die casting
Molding	Injection molding



NB 715	
Size (mm)	W1850×D510×H750
Seat	HDPE
Frame	Aluminum die casting
Molding	Blow molding



NB 721	
Size (mm)	W1850×D480×H745
Seat	HDPE
Frame	Aluminum die casting
Molding	Blow molding



NB 824	
Size (mm)	W1810×D490×H760
Seat	HDPE
Frame	Steel
Molding	Injection molding



NB 825	
Size (mm)	W1810×D460×H810
Seat	HDPE
Frame	Steel
Molding	Blow molding

# CERTIFICATES

## Corporate management

### Quality



ISO 9001

### Environment



ISO 14001

### Safety



OHSAS 18001



BS 5852, Source 5 (NSC 2011)



BS 5852, Source 5 (NSC 1015)

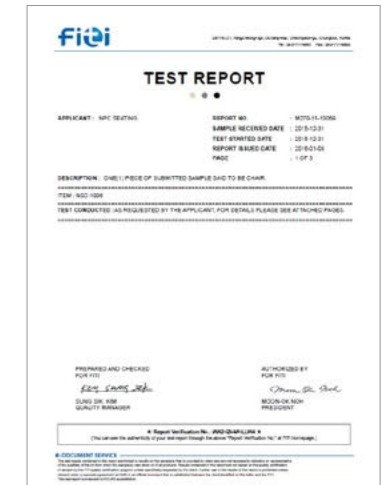

BS 5852, Source 5 (NSC 1006)

## Product management



Telescopic System



BS 5852, Source 5 (NSC 2040)

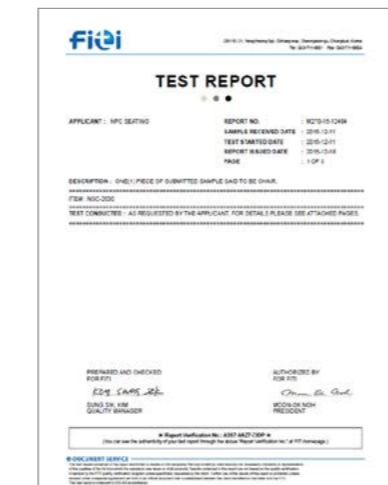

BS 5852, Source 5 (NSC 2030)



EN 12727, Level 4 (NSC 1015)



EN 12727, Level 4 (NSC 1006)



EN 12727, Level 4 (NSC 3023)

Patents

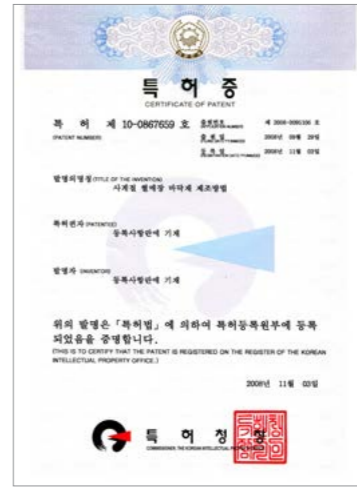

Gwangju Moodeung Baseball Field	14,785 seats	Youngwol Public Field	1,716 seats	Mokdong Baseball Field	6,194 seats	Daegu Gwagiwon Gymnasium	277 seats	Yongin Sungbok High School	156 seats
Gwangju Stadium	25,141 seats	Gunpo City Hall	1,248 seats	Gwangju Moodeung Baseball Field	2,000 seats	Jeju Wolang Elementary School	500 seats	Soongsil University Student Center	204 seats
Jeonju Public Football Field	24,000 seats	Yecheon Archery Field	1,320 seats	Busan Sajik Tennis Court	463 seats	Misari Speed Boat Racing Track	1,342 seats	Gwangju Bukgu Gymnasium	332 seats
Jeonju Public Baseball Field	11,854 seats	Youngnam University Soccer Field	2,376 seats	Youngnam Supplementary Stadium	446 seats	Incheon Namdong Stadium	5,254 seats	Geoje Recycle Center	100 seats
Daejeon Public Stadium	11,000 seats	Gosung Gymnasium	1,080 seats	Gunsan Baseball Field	4,006 seats	Changnyung Public Gymnasium	376 seats	Daegyo Badminton Court	460 seats
Olympic Rowing Stadium	9,980 seats	Jeonju Stadium	5,017 seats	Injae Sudden Attack Arena	288 seats	Jecheon Tennis Court	1,260 seats	Sasang Danurim Center	241 seats
Mokpo Swimming Arena	6,575 seats	Cheolwon Public Field	2,928 seats	Choongnam University Stadium	504 seats	Busan High School of Mechanical Engineering	90 seats	Incheon Football Field Skybox	121 seats
Wonkwang University Gymnasium	5,220 seats	Jeonju Swimming pool	1,892 seats	Incheon Seogu Fire Station	126 seats	Incheon Ganghwa Taekwondo Arena	1,428 seats	Suwon AK Plaza	171 seats
Gunsan Baseball Field	12,606 seats	Pyeongtek Yichoong Culture Center	1,864 seats	Choongbuk Yeoungdong Gymnasium	1,347 seats	Namyangju Geumgok Reserve Forces Training Center	734 seats	Busan Gyungnam Horse Racing Track	200 seats
Sungnam Gymnasium	5,200 seats	Jamsil Stadium	600 seats	Seoul Students' Gymnasium	666 seats	Daegu Dalsung Sports Park	6,958 seats	Asan Gymnasium	1,548 seats
Mokdong Gymnasium	5,000 seats	Jeungpyung Sports Center	1,357 seats	Yeosu Jinnam Main Stadium	19,761 seats	Soowon Media Center	155 seats	Anyang Police Station	204 seats
Daejeon Gymnasium	5,220 seats	Olympic Tennis Court	878 seats	Gwangju Moodeung Baseball Field	1,000 seats	Incheon Dowon Gymnasium	143 seats	Dangjin Cultural Sports Center	142 seats
Jeonju Gymnasium	4,900 seats	National Theater	1,900 seats	Incheon Moonhak Baseball Field	250 seats	Gyewon Art School	154 seats	Changwon KBS	179 seats
Gunsan Gymnasium	4,324 seats	Chongsong Sports Field	412 seats	Incheon Military Camp	1,400 seats	Jeju Stadium	17,672 seats	Hapjung Interpark Art Center	294 seats
Daejeon EXPO Main Stage	17,918 seats	Gwangju Moodeung Baseball Field	4,100 seats	Chungyang Public Field	928 seats	Gyungju Munhwa High School	830 seats	Andong Gymnasium	1,288 seats
Busan Guduk Stadium	5,140 seats	Guduk Stadium	1,819 seats	Gwangju Moodeung Baseball Field	168 seats	Incheon Asian Game Main Stadium (temporary)	14,952 seats	Gungook University Global Campus	676 seats
Daejeon Cycle Stadium	2,546 seats	Nonsan Army Camp	528 seats	Chuncheon Songam Tennis Court	4,219 seats	Incheon Asian Game Main Stadium (fixed)	35,490 seats	Incheon Boat Racing Track	891 seats
Yeosu Public Stadium	4,405 seats	Chungbuk Seohae Academy	438 seats	Jamsil Baseball Field	860 seats	Jeju University	761 seats	Gosung Public Gymnasium	493 seats
Pocheon Stadium	5,964 seats	Hongcheon Pre-School	458 seats	Mokpo Yudal Stadium	9,400 seats	Chungmu Gymnasium	1,441 seats	Wonju Gymnasium	1,080 seats
Hanshin University Stadium	3,002 seats	Namsan Pre-School	486 seats	Incheon LNG	654 seats	Jeonju Gymnasium	554 seats	Misari Speed Boat Racing Track	1,020 seats
Suncheon Palma Stadium	13,125 seats	Goheung Gymnasium	2,745 seats	Jamsil Baseball Field	9,657 seats	Buyeo Eunsanmyun Gymnasium	162 seats	Ganghwa Taekwondo Arena	1,428 seats
Yeosu Stadium	9,235 seats	Gwanak IT High School	406 seats	Bucheon Songnae Gymnasium	620 seats	Buan Sports Park Tennis Court	306 seats	Daeduk University Gymnasium	292 seats
Moodeung Baseball Field	9,250 seats	Busan Sajik Baseball Field	929 seats	Incheon Moonhak Baseball Field	230 seats	Buyeo Gudeurae Sports Park	500 seats	Gyungju Moonhwa High School	830 seats
Jeonju Ice Rink	2,479 seats	Bosung Public Field	4,080 seats	Gunsan Baseball Field	885 seats	Ulsan Arena For Disabled	168 seats	Younggwang Art Hall	164 seats
Sangju Sports Field	15,046 seats	Gungook University	1,712 seats	Pyongtaek Haengsung Gymnasium	290 seats	Bosung Public Field	4,196 seats	Goheung Agricultural Technology Center	160 seats
Iksan Gymnasium	5,106 seats	Gyungju Public Field	10,638 seats	Jamsil Gymnasium	3,998 seats	Jincheon Institute Of Justice	1,443 seats	Choonchun Bongui High School	204 seats
Nagano Olympic Main Stadium	30,000 seats	Gwangju High School of Mechanical Engineering	421 seats	Jinju Stadium	21,207 seats	KASC Sports Hall & Athletics Stadium	10,593 seats	Ulsan Gymnasium for disabled	168 seats
Jeju Stadium	20,163 seats	Hongcheon Pre-School	900 seats	Wonju Stadium	15,042 seats	Soowon Gwanggyo Ssireum Arena	852 seats	Jincheon Institute Of Justice	180 seats
Olympic Tennis Court	10,046 seats	Naju High School of Mechanical Engineering	432 seats	Youngam F-1 Grand Prix	16,872 seats	Boochon Aiiins World	500 seats	Sejong Welfare Center	212 seats
Gunsan Baseball Field	4,206 seats	Jochiwon Sports Park	2,734 seats	Buan Gyehwa Town	136 seats	Gwangju International Tennis Court	4,398 seats	Namyangju Children Vision Center	230 seats
Gongju Gymnasium	3,004 seats	Inji Elementary School	412 seats	Jeju Elephants' Land	1,026 seats	Eunseok Elementary School	682 seats	Hwasung Banwol High School	158 seats
Gyungju Gymnasium	4,602 seats	Chuncheon Baseball Field	6,570 seats	Cheolwon Public Field	3,964 seats	Youngju Public Field	1,730 seats	Doowon University Rachael hall	242 seats
Gyungju EXPO	3,200 seats	Yanggu Stadium	3,964 seats	Ulsan Business High School	355 seats	Jeju Youngju High School	876 seats	Ulsan Gwang Dong Elementary School	222 seats
Pocheol Football Field	18,959 seats	Buan Public Field	3,681 seats	Jinhae Women's High School	264 seats	Incheon Moonhak Baseball Field	1,400 seats	World Water Forum	220 seats
Jeongeup Public Stadium	12,400 seats	Yanggu Stadium	3,000 seats	Incheon Moonhak Baseball Field	3,030 seats	Gwangju International Archery Field	1,066 seats	Kardinia College	1,593 seats
Gimjae Gymnasium	2,045 seats	Iksan Stadium	15,685 seats	Boryung Public Field	136 seats	Kim Soo Nyung Archery Field	120 seats	Diamond Creek	916 seats
Gimjae Sports Field	6,146 seats	Jamsil Gymnasium	602 seats	Uljin Stadium	4,378 seats	Rural Development Administration	313 seats	Siri Fort	2,500 seats
Sangmyung University Field	3,168 seats	Soowon Women's University	419 seats	Jungsun Main Stadium	11,730 seats	Shinsegae Emart, Seongsu	200 seats	Model Farms High School	188 seats
Woolsan Gymnasium	5,047 seats	Seosan High School of Farming	472 seats	Jungsun Supplementary Stadium	948 seats	Magoksa	202 seats	MPC Leibler College	330 seats
Jinan Culture Hall	1,530 seats	Sokcho Pre-School	416 seats	Jungsun Gymnasium	1,712 seats	Shinsegae Centum City	224 seats	New Performing Arts Center	200 seats
Jinju Air Force Education Training Command	2,087 seats	Gosung Stadium	596 seats	Hyochang Field	1,688 seats	Shinsegae Centum Theater	198 seats	Indoor Sports Hall	752 seats
Gumi Sports Field	1,164 seats	Seogwipo World Cup Stadium	1,168 seats	Hwasung Sports town	42,448 seats	Seowon Elementary School	421 seats	The Friends' School	330 seats
Bomoon Women's High School	1,105 seats	Hanlim Stadium	3,630 seats	Pohang Gymnasium	486 seats	Daehak Ro Art One	599 seats	St. Monica	200 seats
Jeju Festival	3,200 seats	Euisung Stadium	8,120 seats	Yangpyung Baseball Field	780 seats	Goam Joong High School	120 seats	Sydney Catholic Vocational College	200 seats
Tancheon Stadium	21,454 seats	Goheung Public Field	7,445 seats	Changnyung Bugok Training Center	1,139 seats	Batanggol Theater	145 seats	Yeppoon Town Hall	164 seats
Woosuk University Concert Hall	1,640 seats	Incheon Samsan Sports Field	903 seats	Jeonju Gymnasium	3,798 seats	Masong Joong High School	200 seats	Anderson Creek	440 seats
Gochang Public Field	6,018 seats	Milyang Public Field	8,049 seats	Buyeo Stadium	6,005 seats	CJ Culture Space	314 seats	Liebler College	286 seats
Ansan Archery Field	1,500 seats	Hadong Geumnam Gymnasium	507 seats	Gwangju Kia Gymnasium	352 seats	Jangan High School	164 seats	Mackillop College	462 seats
Yeongnam University Outdoor Stage	2,930 seats	Namsan High School	412 seats	Yangyang Cycle Track	1,405 seats	City Safety Training Center	110 seats	Red Bank	120 seats
Wongwang University	4,450 seats	Youngju Public Sports Center	2,610 seats	Incheon Football Field	20,467 seats	Gimpo Youth Training Center	201 seats	PLM Primary School	260 seats
Jangsung Theater	1,279 seats	Gimcheon University	522 seats	Gumi Public Field	1,552 seats	Gyunggi Foreign Language Training Center	208 seats	ITE Central B/B Theater	160 seats
Hapcheon Public Field	6,230 seats	Goomi Base Camp	296 seats	Guduk Baseball Field	500 seats	Shinsoo Middle School	116 seats	E-Green Primary School	250 seats
Misari Boat Racing Track	1,275 seats	Gilsang Stadium	671 seats	Asan Ice Rink Arena	2,200 seats	Shinsegae Department Store, Myungdong	198 seats	Aquinas College	360 seats
Jamsil Baseball Field	6,510 seats	Seoul Sports Center	196 seats	Asan Gymnasium	1,549 seats	Yeongdeungpo Haja Center	204 seats	Tai Po Center	140 seats
Incheon Moonhak Football Field	50,256 seats	Suncheon Palma Stadium	566 seats	Dangjin Sports Center	142 seats	Shinwoo Elementary School	106 seats	Emmaus College	286 seats
Incheon Moonhak Baseball Field	30,584 seats	Gwangju Moodeung Stadium	1,043 seats	Pohang Baseball Field	4,557 seats	Jinju Moduk Tennis Court	340 seats	Pluim Park	784 seats
Gwangju World Cup Stadium	42,880 seats	Jeonju Indoor Gateball	128 seats	Olympic Tennis Court	400 seats	Marine Corps Gymnasium	128 seats	Torquay Cricket and Football	162 seats
Jeonju World Cup Stadium	42,477 seats	Youngcheon Gymnasium	552 seats	JeJu Public Field	120 seats	Jangsaengpo Whale Center	160 seats	Southland Stadium	3,500 seats
Jeju World Cup Stadium	42,256 seats	Gyungnam University	138 seats	Gwangju Seogang Middle School	380 seats	Seoul Medical Center	300 seats	Elim Church	300 seats
Anyang Sports Field	2,150 seats	Jangchoog Stadium	1,650 seats	Jamsil Main Stadium	118 seats	Ulsan Daehyun Gymnasium	1,040 seats	SHHK	264 seats
Seogyung University	1,456 seats	Wonju World Tattoo Festival	4,340 seats	Jeju Horse Racing Track	962 seats	Ganghwa Culture Hall	214 seats	Muswellbrook Shire Council	432 seats
Gyungdong School	2,553 seats	Dongdocheon Stadium	13,983 seats	Nonsan Hoguk Yeonmusa	3,130 seats	Andong Korean Culture Hall	148 seats	Sydney Gymnastic & Aquatic Center	1,100 seats
Yeosu Jinnam Arena	2,111 seats	Jamsil Main Stadium	350 seats	Hwasoon LeeYongDae Badminton Court	953 seats	Galleria Department Store, Buldang	237 seats	Central Coast Adventist School	880 seats
Gangjin Sports Center	2,005 seats	Gunsan Baseball Field	176 seats	Gwangju International Tennis Court	300 seats	Samchunpo Public Field	325 seats	Wyong Council	300 seats
Jamsil Baseball Field	10,200 seats	Jeju Aehyang Stadium	980 seats	Mokpo Yeondong Elementary School	176 seats	Sabook Middle School	120 seats	Nth Sydney TAFE	86 seats
Jeonju Stadium	5,600 seats	Jeju Mirirnae Sports Park	304 seats	Seoul AT Center	1,500 seats	Sunggyungwan University Gymnasium	200 seats	St. Edwards College	198 seats
Busan Gijang Stadium	3,397 seats	Goonsan Wolmyung Tennis Court	558 seats	Jeju Wimi Middle School	370 seats	Incheon Football Field	988 seats	Duncraig Senior High School	202 seats
Seorabul University	1,828 seats	Gwangju Moodeung Stadium	1,500 seats	Gimje Football Field	200 seats	Moonhak Baseball Field Skybox	477 seats	Wyong Christian School	200 seats
Jinju Gyungsang University Field	2,834 seats	Sangju Public Field	2,754 seats	Moonkyung Army Athletic Field	19,642 seats	Moonbaekmyun City Hall	106 seats	JECC	760 seats
Gurae Gymnasium	2,152 seats	Seoul Sports High School Swimming Arena	558 seats	Busan Guduk Stadium	8,135 seats	Ansung City Hall	145 seats	United Interior	650 seats
Hanbat University	2,235 seats	Yeonmoor Public Sports Park	384 seats	Gyungju Public Stadium	12,006 seats	Gwangun Ice rink	164 seats	Center For International Forestry Research	230 seats
Yeongnam University	4,740 seats	Jincheon Stadium	5,211 seats	Incheon Moonhak Baseball Field	940 seats	Haman Gymnasium	475 seats	KASC Sports Hall & Athletics Stadium	10,593 seats
Doowon School of Engineering	723 seats	Gwangju Multi Stadium	1,450 seats	Masan Baseball Field	722 seats	Goyang Arena	1,812 seats	Golden Grove	329 seats
Ryugyung JeongJooYoung Gymnasium	11,370 seats	Incheon Public Field	396 seats	Andong Public Field	1,614 seats	Goyang Arena Swimming pool	244 seats	Springwood Civic Center	428 seats
Yongin Gymnasium	1,500 seats	Jamsil Student Gymnasium	330 seats	Jangsoo Public Field	732 seats	Goyang Arena Squash	256 seats	Guilford College	607 seats
Youngju Public Field	1,018 seats	Boondang Outdoor Skate Rink	288 seats	Ansan Sangnok Gymnasium	2,587 seats	Posco Pohang Gymnasium	644 seats	Taurama Aquatic Center	901 seats
Jeongeup Gymnasium	1,204 seats	Madeul Geunlin Park	446 seats	Namyangju Reserve Forces Training Center	680 seats	Yongin Everland Racing Track	6,000 seats	SJG Indoor Stadium	1,104 seats



WE DESIGN AND MANUFACTURE

SPECTATOR SEATS

RETRACTABLE SEATING PLATFORM

GRANDSTAND / BLEACHER

© 2016 NPC SEATING. All rights reserved. The contents of this catalogue which refer to texts, images, graphics, code, source, are the exclusive property of NPC SEATING CO., LTD. The reproduction, public communication, modification, distribution of any of these elements is forbidden in accordance with the terms of the law

HEAD QUARTER

Address: 349 Geumpan-Ro, Dongjin-Myun, Buan-Gun, Jeollabuk-Do, Korea

Tel: +82 63 581 3071

Fax: +82 63 584 6324

SALES

Address: 255 Pangyo-ro, Pangyo Innovalley Bld F, 5th Fl Bundang-Gu, Seongnam-Si, Gyeonggi-Do, Korea

Tel: +82 31 698 2529

Fax: +82 31 698 2555

Email: [npcseating@npcseating.com](mailto:npcseating@npcseating.com), [npc.seating@gmail.com](mailto:npc.seating@gmail.com)

Website: [www.npcseating.com](http://www.npcseating.com)